



Please read this manual before operating

PT 5

ULTRASONIC PERIODONTAL TREATMENT DEVICE

INSTRUCTION MANUAL

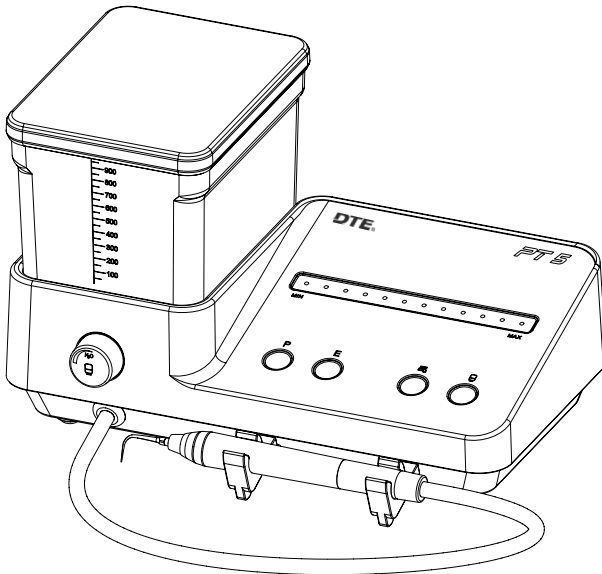

www.glwoodpecker.com

GUILIN WOODPECKER MEDICAL INSTRUMENT CO., LTD.

Contents

1. The installation and components of equipment	1
2. Installation and adjustment	4
3. Maintenance and sterilization	6
4. Precaution	9
5. After service	10
6. Environmental protection	10
7. Manufacturer's right	11
8. Symbol instruction	11
9. For technical data, please contact	12
10. EMC-Declaration of conformity	12
11. Statement	15

1. The installation and components of equipment

1.1 Instruction

Guilin Woodpecker Medical Instrument Co., Ltd. is a professional manufacturer in researching, developing and producing ultrasonic scalers. The product is mainly used for teeth cleaning and also an indispensable equipment for teeth disease prevention and treatment.

The ultrasonic periodontal treatment device PT 5 has scaling, perio functions with the following features:

- a) Circular vibration orbit, scaling and polishing together.
- b) Small vibrating amplitude, enjoy the painless treatment.
- c) Titanium scaling tips, no injury to cementum.
- d) Clinical solutions are applicable for automatic water supply mode, including
Hydrogen peroxide, sodium hypochlorite, chlorhexidine
- e) LED Handpiece, better visibility.
- f) Automatic frequency tracking ensures that the machine always works on the best frequency and more steadily.
- g) Digital control, easy operation and more efficient for scaling.
- h) The silicon-cover can be autoclaved to high temperature 134°C and high pressure 0.22Mpa.

1.2 Components

1.2.1 The components of machine are listed in the packing list.

1.2.2 Product performance and structural composition

Periodontal treatment device PT 5 is composed of electro circuit, water way, handpiece, periodontal treatment device tip and foot pedal.

1.2.3 Scope of application

Periodontal treatment device PT 5 is used for the dental calculus elimination.

1.3 The main technical specifications

1.3.1 Technical specifications of PT 5

- a) Main unit input: 220-240V~ 50Hz/60Hz 150mA
- b) Output primary tip vibration excursion: $\leq 60\mu\text{m}$
- c) Output half-excursion force: $< 2\text{N}$
- d) Output tip vibration frequency: 28kHz~42kHz
- e) Output power: 3W to 20W
- f) Main unit fuse: T0.5AL 250V
- g) Water pressure: 0.01MPa to 0.5MPa
- h) Weight of main unit: 2.0kg
- i) Operating mode: Continuous operation

- j) Type of protection against electric shock: class II equipment
- k) Degree of protection against electric shock: Type BF applied part
- l) Applied part of the equipment: handpiece and tip
- m) Degree of protection against harmful ingress of water: Ordinary equipment, the foot switch is drip-proof equipment (IPX1)
- n) Degree of safety of application in the presence of a Flammable Anesthetic Mixture with air, Oxygen or Nitrous Oxide: Equipment not suitable for being used in the presence of a flammable anesthetic mixture with air, oxygen or nitrous oxide.

1.4 Instruction of the main components

Instruction and component sketch map

1.4.1 Front of the main unit sketch map

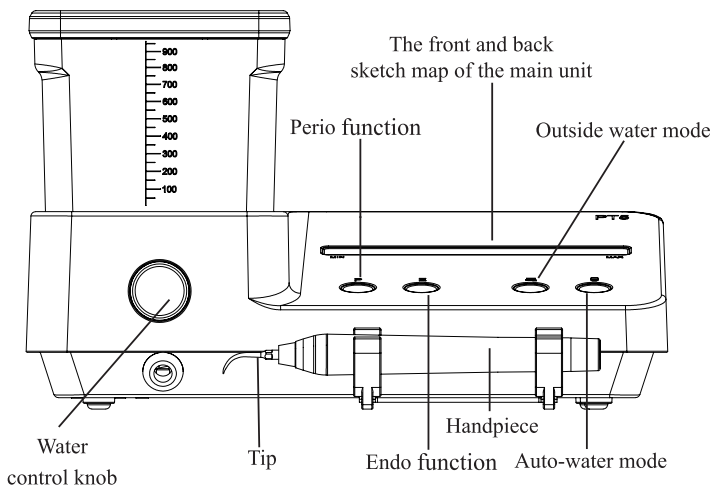

Picture 1

1.4.2 Back of the main unit sketch map

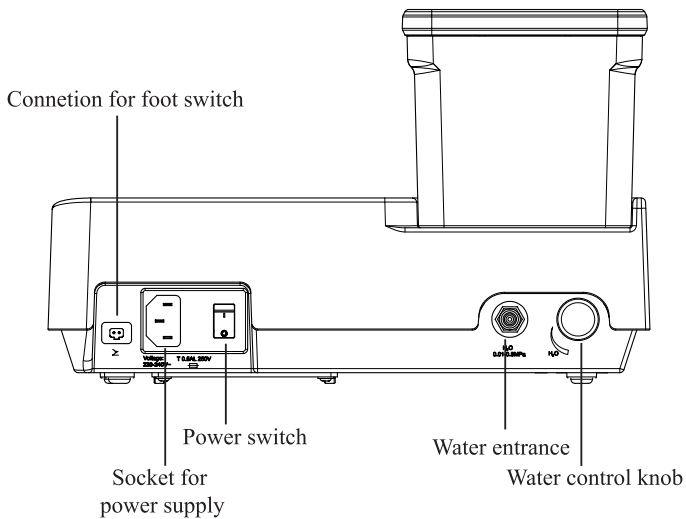

Picture 2

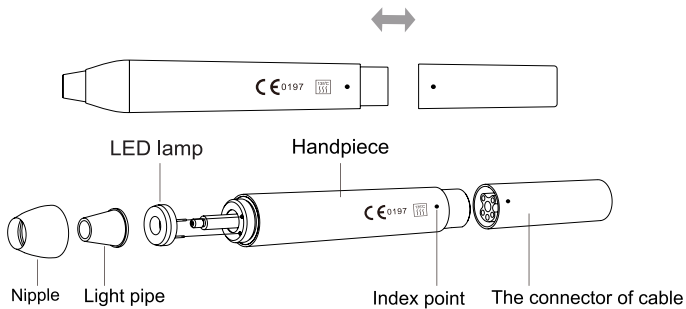

Picture 3

1.4.3 Instruction of using wrench

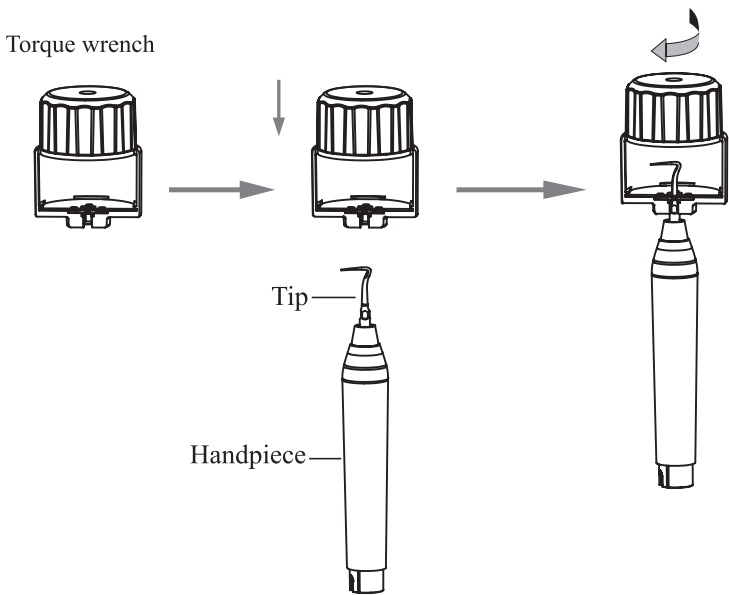

Picture 4

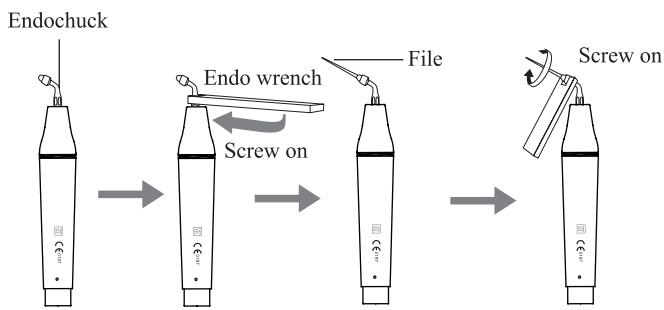

Picture 5

2. Installation and adjustment

2.1 Operation

2.1.1 Open the packing box, make sure that all the parts and accessories are complete according to the packing list, take the main unit out of the box, and put it on the the stable plane facing to the operator.

2.1.2 Turn the water control knob to the max according to the picture direction, Do not screw it over tight in case of damage. [note 1]

2.1.3 Insert the plug of the foot switch to its socket. (see picture 2)

2.1.4 Fill the box with water or connect one end of the water pipe to the water entrance, and the other end to the clean water source. (see picture 2)

2.1.5 Turn off the power switch and plug the power cord to socket.

2.1.6 Turn on the power switch, the power indicator lighted and the machine is ready for work. Touch panel is applied to this machine, water supply mode or power can be adjusted by directly touching the water supply mode identification or power indicator on the touch panel.

2.1.7 In the condition of normal working, the frequency of the tips is very high, light touch and a certain to-and-fro motion will eliminate the tartar without obvious heating, overexertion and overrate are forbidden.

2.1.8 Vibrating intensity: Adjust the vibrating intensity according to your need, usually adjust to the middle grade, and adjust the vibrating during the clinical treatment according to the patient's sensitivity and the rigidity of the tartar.

2.1.9 Step on the foot switch, the tip begins to vibrate, and the LED lamp on the top of the handpiece shines. Release the foot switch, the LED lamp keep shining for 10 seconds.

2.1.10 Water volume adjustment: Step on the foot switch, and the tip begins to vibrate, then turn the water control switch to fine spray to cool down the handpiece and clean the teeth.

2.1.11 The handpiece can be handled in the same gesture as a pen in hand.

2.1.12 Make sure not to make the end of the tip touch the teeth vertically, and not use too much pressure when the tip touch the surface of the teeth, in order not to hurt the teeth and the tip.

2.1.13 After finishing operation, keep the machine working for 30 seconds with the water supply to clean the handpiece and the tip.

2.1.14 Unscrew the scaling tip and sterilize it.

Note: Don't screw the scaling tips when stepping on the foot switch, and the machine is working.

2.2 Endo function

2.2.1 Usage process

a) Fix endochuck to handpiece by endo wrench (See Figure 6).

b) Unscrew the screw cap on the endochuck.

c) Put the ultrasonic file into the hole in the front of endochuck.

d) Screw the screw cap with endo wrench to tight up the ultrasonic file.

e) Press "E" key, turn to endo function.

f) When ultrasonic periodontal treatment turns into endo function, only the first

power indicator is on and the power is at the 1st grade. Put the ultrasonic file into the patient's root canal slowly, step on the foot switch to start endo treatment. During the treatment, turn up the power gradually according to the needs.

2.2.2 Notice

- a) When fixing endochuck, it must be screwed down.
- b) The screw cap on the endochuck must be screwed down.
- c) Don't press it too much when the ultrasonic file is in root canal.
- d) Don't step on the foot switch until the ultrasonic file is in root canal.
- e) The power range of endo treatment is advised from the 1st to the 5th grade.

2.3 Cleaning mode

It is suggested to wash and disinfect the water pipe after scaling everyday.

The "Cleaning mode" can wash and disinfect the water pipe, reducing the crystal substance and bacterias in water pipe.

Operation:

1. Put distilled water or mineral substance into water tank.
2. Press the automatically water supply button and outside water button at the same time (1s) to start the "Cleaning mode" after buzzer beeps. The button of automatic water supply mode would flash and others buttons will go out.
3. Link the connector and the handpiece with the drainage device.
4. Step the pedal, the device would start self-cleaning. After that the pedal could be loosened.
5. After cleaning for 30s, the device would stop self-cleaning. Or you can stop by step the pedal again or press the automatic water supply button.
6. After cleaning, press the automatically water supply button and outside water button at the same time (1s) to exit the "Cleaning mode" after buzzer beeps.

3. Maintenance and sterilization

3.1 All the scaling tips, Handpiece, wrench can be autoclaved.

- 3.1.1 Autoclaved under high temperature, pressure, time:
134°C, 2.0bar~2.3bar (0.20MPa~0.23MPa), 4min.

3.2 The tip and wrench can be cleaned by ultrasonic cleaner.

3.3 Troubles shooting

Fault	Possible	Solutions
The scaling tip doesn't vibrate and no water flowing out when stepping on the foot switch.	The plug is in loose or wrong contact.	Connect the power plug well.
	The foot switch is in loose contact.	Connect the switch well.
	The fuse is broken.	Change a new fuse.
The scaling tip doesn't vibrate, but there is water flowing out when stepping on the foot switch.	The scaling tip is in loose contact.	Screw it tightly (see picture 4)
	The connector plug of the handpiece with the circuit board is in loose contact.	Contact with the local distributor or manufacturer.
	Malfunction of the handpiece.	Contact with the local distributor or manufacturer.
The scaling tip vibrates but there is no spray come out when stepping on the foot switch.	The water control switch is off.	Turn on the switch [note 1].
	There is impurity in the solenoid valve.	Contact with the local distributor or manufacturer.
	The water pipe is jammed.	Clean water pipe by multi-function syringe [note 2].
There is water flow out when turn off the power.	There is impurity in the solenoid valve.	Contact with the local distributor or manufacturer.
The handpiece generates heat.	The amount of spouting water is too little.	Turn the water control switch to a higher grade [note 1].
	The potentiometer is broken.	Change a new one.
The amount of spouting water is too little.	The water control knob is a low grade.	Turn the knob to a high grade [note 1].
	The water pressure is not enough.	Enhance the water pressure.
	The water pipe is jammed.	Clean the water pipe by multi-function syringe [note 2].

Fault	Possible	Solutions
The vibration of the tip becomes weak.	The tip hasn't been screwed tightly or becomes loose because of vibration.	Screw the scaling tip tightly (Picture 4).
	The tip is damaged.[note 3]	Change a new one.
	The tip is damaged [note 3].	Change a new one.
The vibrating intensity control knob is seized up.	The potentiometer is damaged.	Contact with the local distributor or our company.
The u-file doesn't vibrate.	The screw is loose.	Tighten it.
	Endochuck is damaged.	Change a new one.
There is noise coming from the endochuck.	The screw is loose.	Tighten it.

If the troubles still can't be solved, please contact with the local distributors or manufacturer.

3.4.2 Notice

[Note 1] The water control knob can adjust the water volume according to the image.

[Note 2] To clean the water pipe with the multi-function syringe of the dental unit (see picture 4):

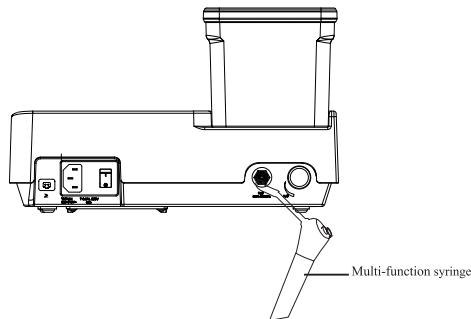

Picture 6

- Snip the water pipe at a distance of 10cm to 20cm from the water entrance.
- Turn on the power switch, get through to the power.
- Connect the multi-function syringe of the dental unit to the water pipe.
- Screw off the scaling tip or pull out the handpiece.
- Step on the foot switch.
- Turn on the switch of the multi-function syringe, press the air or water into

the water pipe to clean and eliminate the impurity.

[Note 3] If the scaling tip has been screwed on tightly and there is fine spray too, the following phenomena show that the scaling tip is damaged:

- a) The vibrating intensity and the pulverization degree become weak obviously.
- b) During operating, there is some buzz when the scaling tip is working.

4. Precaution

4.1 Usage notice

4.1.1 Keep the periodontal treatment device clean before and after operation.

4.1.2 The scaling tip, wrench and handpiece must be sterilized before each treatment.

4.1.3 Don't screw the scaling tip when stepping on the foot switch.

4.1.4 The scaling tip must be fastened. There must be fine spray coming out from the tip when operating.

4.1.5 Change a new one when the tip is damaged or worn excessively.

4.1.6 Don't twist or rub the tip.

4.1.7 While periodontal treatment device works, the heat of scaling tip will become higher if there is no water flowing out, please keep the water flow smoothly.

4.1.8 Don't use impure water source, please use pure water source, and normal brine can be used.

4.1.9 If use the water source without hydraulic pressure, the water surface should be one meter higher than the head of the patient.

4.1.10 Don't knock or rub the handpiece.

4.1.11 Please put the power plug into the socket and make it easy to pull out, to make sure it can be pulled out in emergency.

4.1.12 When using the equipment, please keep the water get through smoothly, otherwise patient's tooth surface would be injured by overheat in the handpiece.

4.1.13 After operating, turn off electrical source, and then pull out the plug.

4.1.14 As a professional manufacturer of medical instruments, we are only responsible for the safety on the following conditions:

I. The maintenance, repair and modification are made by the manufacturer or the authorized dealer.

II. The changed components are original of "DTE" and operated correctly according to instruction manual.

4.1.15 The screw thread of the scaling tips produced by other manufacturers maybe coarse, rusty and collapsed, which will damage the screw thread of the handpiece irretrievably. Please use "DTE" brand scaling tip.

4.1.16 Please select a suitable power when using different type of tips.

4.2 Contraindication

4.2.1 The patient who has hemophilia is not allowed to use this equipment.

4.2.2 The patient or doctor who with heart pacemaker is forbidden to use this equipment.

4.2.3 The heart disease patient, pregnant woman and children should be cautious to use the equipment.

4.3 Storage and maintenance

4.3.1 The equipment should be handled carefully and lightly. Be sure that it is far from the vibration, and is installed or kept in a cool, dry and ventilated place.

4.3.2 Don't store the machine together with the articles that are combustible poisonous, caustic, or explosive.

4.3.3 This equipment should be stored in a room where the relative humidity is 10% ~ 93%, atmospheric pressure is 70kPa to 106kPa, and the temperature is -20°C ~ +55°C .

4.3.4 Please turn off the power switch and pull out the power plug when the equipment is not used. If the machine is not used for a long time, please make it get through to the power and water once per month for five minutes.

4.4 Transportation

4.4.1 Excessive impact and shake should be prevented in transportation. Lay it carefully and lightly and don't invert it.

4.4.2 Don't put it together with dangerous goods during transportation.

4.4.3 Avoid solarization and getting wet in rain or snow during transportation.

4.5 Working condition

4.5.1 Environment temperature: +5°C to +40°C

4.5.2 Relative humidity: 30% ~75%

4.5.3 Atmosphere pressure: 70kPa to 106kPa

4.5.4 A temperature of the water at the inlet: not higher than +25°C

5. After service

We offer one year free repair to the equipment according to the warranty card.

The repair of the equipment should be carried out by professional technician. We are not responsible for any irretrievable damage caused by the not professional person.

6. Environmental protection























There are no harmful factors in our product. You can deal with it based on

the local law.

7. Manufacturer's right

We reserve the rights to change the design of the equipment, the technique, fittings, the instruction manual and the content of the original packing list at any time without notice. If there are some differences between blueprint and real equipment, take the real equipment as the norm.

8. Symbol instruction

	Trademark		0197 CE marked product
	Date of manufacture		Manufacturer
	Type BF applied part		Manufacturer
IPX1	Anti-drip device		Recovery
	Used indoor only		Keep dry
	Can be autoclaved		Handle with care
	Mode of outside-water system		Alternating current
	Switch of automatic water supply	P	Periodontal function
H_2O 0.01-0.5MPa	Water entrance pressure 0.01MPa - 0.5MPa	E	Endo function
	Foot switch interface	H_2O 	Adjustment for the water flow
	Humidity limitation for storage		Atmospheric pressure for storage
	Temperature limit for storage		Earth (ground)
	Appliance compliance WEEE directive		
	Follow Instructions for Use		



Authorised Representative in the EUROPEAN COMMUNITY

9. For technical data, please contact



MedNet GmbH
Borkstrasse 10 · 48163 Muenster · Germany

10. EMC-Declaration of conformity

Guidance and manufacturer's declaration - electromagnetic emissions		
The model PT 5 is intended for use in the electromagnetic environment specified below. The customer or the user of the model PT 5 should assure that it is used in such an environment.		
Emissions test	Compliance	Electromagnetic environment - guidance
RF emissions CISPR 11	Group 1	The model PT 5 uses RF energy only for its internal function. Therefore, its RF emissions are very low and are not likely to cause any interference in nearby electronic equipment.
RF emissions CISPR11	Class B	The model PT 5 is suitable for used in domestic establishment and in establishment directly connected to a low voltage power supply network which supplies buildings used for domestic purposes.
Harmonic emissions IEC 61000-3-2	Class A	
Voltage fluctuations / flicker emissions IEC 61000-3-3	Complies	

Guidance & Declaration — electromagnetic immunity

The model PT 5 is intended for use in the electromagnetic environment specified below. The customer or the user of the model PT 5 should assure that It is used in such an environment.

Immunity test	IEC 60601 test level	Compliance level	Electromagnetic environment - guidance
Electrostatic discharge (ESD) IEC 61000-4-2	±6 kV contact ±8 kV air	±6 kV contact ±8 kV air	Floors should be wood, concrete or ceramic tile. If floors are covered with synthetic material, the relative humidity should be at least 30 %.
Electrical fast transient/burst IEC 61000-4-4	±2kV for power supply lines ±1 kV for Input/output lines	±2kV for power supply lines ±1kV for interconnecting cable	Mains power quality should be that of a typical commercial or hospital environment.
Surge IEC 61000-4-5	±1 kV line to line ±2 kV line to earth	±1 kV line to line	Mains power quality should be that of a typical commercial or hospital environment.
Voltage dips, short interruptions and voltage variations on power supply input lines IEC 61000-4-11.	<5 % U_T (>95% dip in U_T) for 0.5 cycle 40 % U_T (60% dip in U_T) for 5 cycles 70% U_T (30% dip in U_T) for 25 cycles <5% U_T (>95 % dip in U_T) for 5 sec	<5 % U_T (>95% dip in U_T) for 0.5 cycle 40 % U_T (60% dip in U_T) for 5 cycles 70% U_T (30% dip in U_T) for 25 cycles <5% U_T (>95 % dip in U_T) for 5 sec	Mains power quality should be that of a typical commercial or hospital environment. If the user of the model PT 5 require continued operation during power mains interruptions, it is recommended that the model PT 5 be powered from an uninterruptible power supply or a battery.
Power frequency (50/60 Hz) magnetic field IEC 61000-4-8	3 A/m	3 A/m	Power frequency magnetic fields should be at levels characteristic of a typical location in a typical commercial or hospital environment.

NOTE U_T is the a.c. mains voltage prior to application of the test level.

Guidance & Declaration - Electromagnetic immunity

The model PT 5 is intended for use in the electromagnetic environment specified below. The customer or the user of the model PT 5 should assure that it is used in such an environment.

Immunity test	IEC 60601 test level	Compliance level	Electromagnetic environment - guidance
Conducted RF IEC 61000-4-6 Radiated RF IEC 61000-4-3	3 Vrms 150 kHz to 80 MHz 3 V/m 80 MHz to 2.5 GHz	3V 3 V/m	Portable and mobile RF communications equipment should be used no closer to any part of the model PT 5, including cables, than the recommended separation distance calculated from the equation applicable to the frequency of the transmitter. Recommended separation distance $d = [3,5\sqrt{V_i}] \times P^{1/2}$ $d = 1,2 \times P^{1/2}$ 80 MHz to 800 MHz $d = 2,3 \times P^{1/2}$ 800 MHz to 2.5 GHz where P is the maximum output power rating of the transmitter in watts (W) according to the transmitter manufacturer and d is the recommended separation distance in meters (m). Field strengths from fixed RF transmitters, as determined by an electromagnetic site survey, ^a should be less than the compliance level in each frequency range. ^b Interference may occur in the vicinity of equipment marked with the following symbol: 

NOTE 1 At 80 MHz end 800 MHz, the higher frequency range applies.

NOTE 2 These guidelines may not apply in all situations. Electromagnetic propagation is affected by absorption and reflection from structures, objects and people.

^a Field strengths from fixed transmitters, such as base stations for radio (cellular/cordless) telephones and land mobile radios, amateur radio, AM and FM radio broadcast and TV broadcast cannot be predicted theoretically with accuracy. To assess the electromagnetic environment due to fixed RF transmitters, an electromagnetic site survey should be considered. If the measured field strength in the location in which the model PT 5 is used exceeds the applicable RF compliance level above, the model PT 5 should be observed to verify normal operation. If abnormal performance is observed, additional

^b Over the frequency range 150 kHz to 80 MHz, field strengths should be less than 3V/m.

**Recommended separation distances between
portable and mobile RF communications equipment and the model PT 5**

The model PT 5 is intended for use in electromagnetic environment in which radiated RF disturbances is controlled. The customer or the user of the model PT 5 can help prevent electromagnetic interference by maintaining a minimum distance between portable and mobile RF communications equipment (transmitters) and the model PT 5 is recommended below, according to the maximum output power of the communications equipment.

Rated maximum output power of transmitter W	Separation distance according to frequency of transmitter m		
	150kHz to 80MHz $d=1.2 \times P^{1/2}$	80MHz to 800MHz $d=1.2 \times P^{1/2}$	800MHz to 2,5GHz $d=2.3 \times P^{1/2}$
0,01	0.12	0.12	0.23
0,1	0.38	0.38	0.73
1	1.2	1.2	2.3
10	3.8	3.8	7.3
100	12	12	23

For transmitters rated at a maximum output power not listed above, the recommended separation distance d in meters (m) can be estimated using the equation applicable to the frequency of the transmitter, where P is the maximum output power rating of the transmitter in watts (W) accordable to the transmitter manufacturer.

NOTE 1 At 80 MHz and 800 MHz, the separation distance for the higher frequency range applies.

NOTE 2 These guidelines may not apply in all situations. Electromagnetic propagation is affected by absorption and reflection from structures, objects and people.

The device has been tested and homologated in accordance with EN 60601-1-2 for EMC. This does not guarantee in any way that this device will not be effected by electromagnetic interference Avoid using the device in high electromagnetic environment.

11. Statement

All rights of modifying the product are reserved to the manufacturer without further notice. The pictures are only for reference. The final interpretation rights belong to GUILIN WOODPECKER MEDICAL INSTRUMENT CO., LTD. The industrial design, inner structure, etc, have claimed for several patents by WOODPECKER, any copy or fake product must take legal responsibilities.

Scan and Login website
for more information



Guilin Woodpecker Medical Instrument Co., Ltd.
Information Industrial Park, Guilin National High-Tech
Zone, Guilin, Guangxi, 541004 P. R. China

Europe Sales Dept. Tel: +86-773-5873196, +86-773-2125222

North America, South America &

Oceania Sales Dept. Tel: +86-773-5873198, +86-773-2125123

Asia & Africa Sales Dept. Tel: +86-773-5855350, +86-773-2125896

Fax: +86-773-5822450

E-mail: woodpecker@glwoodpecker.com, sales@glwoodpecker.com

Website: <http://www.glwoodpecker.com>



MedNet GmbH
Borkstrasse 10 · 48163 Muenster · Germany