

FOCUS™

Intraoral X-ray

User Manual



ENGLISH

REF 214760 rev. 2
0.805.4936 

KAVO
Dental Excellence

Copyright © 2018 by Instrumentarium Dental, PaloDEX Group Oy. All rights reserved.

KaVo™ is either registered trademark or trademark of Kaltenbach & Voigt GmbH in the United States and/or other countries.

FOCUS™ is either a registered trademark or trademark of Instrumentarium Dental, PaloDEX Group Oy in the United States and/or other countries.

All other trademarks are property of their respective owners.

Documentation, trademark and the software are copyrighted with all rights reserved. Under the copyright laws the documentation may not be copied, photocopied, reproduced, translated, or reduced to any electronic medium or machine readable form in whole or part, without the prior written permission of Instrumentarium Dental, PaloDEX Group Oy.

The original language of this manual is English.

Instrumentarium Dental, PaloDEX Group Oy reserves the right to make changes in specification and features shown herein, or discontinue the product described at any time without notice or obligation. Contact your Instrumentarium Dental, PaloDEX Group Oy representative for the most current information.



Manufacturer

Instrumentarium Dental, PaloDEX Group Oy
Nahkelantie 160
FI-04300 Tuusula
FINLAND

Tel. +358 10 270 2000
www.kavokerrgroup.com

For service, contact your local distributor.

1	Introduction	1
1.1	FOCUS™ Intraoral X-ray	1
1.2	Intended use	1
1.3	User profile	2
1.4	Symbols that may appear on the unit	3
1.5	Type and version	5
1.6	Labels on the unit	6
1.7	Configurations	7
1.8	Radiation protection guidelines	9
1.9	Manufacturer's liability	10
1.10	Disposal	11
2	Unit description	12
2.1	Main parts	12
2.2	Cones	13
2.3	Symbols on remote control	15
3	Using the unit	17
3.1	Precautionary actions for safe use	17
3.2	Switching the power on/off	17
3.3	Selecting the cone	18
3.4	Selecting the exposure parameters	18
3.5	Positioning the patient	20
3.6	Taking an exposure	22
3.7	Monitoring of dose levels	22
4	Default settings	23
4.1	Program mode	23
4.2	Programmable anatomical time settings	24
5	Error messages	25
6	Maintenance	27
6.1	Cleaning	27
6.2	Disinfecting	27
6.3	Periodic maintenance	28
6.4	Radiation dose measurement	29
6.5	Changing the fuses	30
7	Technical data	31
7.1	Technical specifications	31
7.2	EMC declaration	35
8	User's statement	43
9	Recommended exposure times	49

1 Introduction

1.1 FOCUS™ Intraoral X-ray

FOCUS (hereafter called “the unit”) is a microprocessor controlled intraoral x-ray unit with a HF DC generator. The unit produces high quality dental images with film, imaging plates or digital sensors.

The well-balanced support arm is easy to move and very stable, keeping the unit motionless during the exposure. The unit’s proprietary design has the VHF DC generator built into the horizontal part of the units support arm enabling greater reliability and ease of installation and service.

The VHF DC generator keeps the patient dose to the minimum. The user friendly remote control features pre-programmed anatomical time settings making the exposure selection quick and effortless. These settings can be reprogrammed if needed.

Other user settings include selecting 60 or 70 kV, setting exposure times between 0.02 and 3.2 seconds, and pediatric or adult modes. Exposures can be made directly from the remote control panel or with the optional remote exposure button. With a choice of arm lengths and ability to mechanically mount the unit in different configurations, the unit is a fully customizable x-ray system.

As the manufacturer we strongly recommend that you read this manual before placing the unit into service.

NOTICE! The unit must be installed according to the Installation manual by a qualified technician. Only trained personnel should be allowed to operate the unit.

1.2 Intended use

The unit is intended to be used for producing diagnostic x-ray radiographs of dentition, jaws and other oral structures.

CAUTION! USA only: Federal law restricts this device to sale by or on the order of a dentist or other qualified professional.

1.3 User profile

The unit is intended only for professionally qualified dental or medicinal personnel.

The typical user is a dental nurse with specific training for using dental X-ray units.

1.4 Symbols that may appear on the unit

The following symbols are used in the unit:



Name and address of the manufacturer



Serial number



X-ray source assembly: emitting



Radiation warning



Radiation generating unit



Focal spot



Filtration



Connector for remote control



Protective ground



Type B applied part



Dangerous voltage



ON or enabled



OFF or disabled



Operating instructions

Refer to operating instructions for more information. The operating instructions can be supplied electronically or in paper format



General caution

Rx only

Caution: Federal law restricts this device to sale by or on the order of a licensed healthcare practitioner.



Do not reuse



Recyclable



Stacking limit

Max. 4 transportation packages may be vertically stacked



CE (0537) symbol

MDD 93/42/EEC



ETL Mark

Conforms to UL STD 60601-1

Certified to CSA



This symbol indicates that the waste of electrical and electronic equipment must not be disposed as unsorted municipal waste and must be collected separately. Please contact an authorized representative of the manufacturer for information concerning the decommissioning of your equipment.

1.5 Type and version

The type and version of the unit is defined in the main label of the unit located on the under side of the horizontal arm and in the tube / HV generator housing assembly label on the tube head. The unit is class I, type B and with IP-20 protection.

The focal length is defined in the cone label in addition to type and version.

The software version is momentarily displayed on remote control display after switching the unit on.

1.6 Labels on the unit



①	<p>Type: Focus Manufactured: February 2015 115 V~ 50 / 60 Hz 7.63 A SN F24710 230 V~ 50 / 60 Hz 3.55 A</p> <p> IP20 This product complies with DHHS 21 CFR Chapter I, Subchapter J at the date of manufacture.</p> <p> 0537 Rx only ETL CLASSIFIED CONFORMS TO UL STD 60601-1. CERTIFIED TO CSA STD C22.2 NO 601.1.</p> <p> Instrumentarium Dental, PaloDEX Group Oy, Nahkelantie 160, FI-04300 TUUSULA, Finland</p> <p>2015-02 Intertek 216129 200054-02</p>	②	<p>TUBE/HV GENERATOR HOUSING ASSEMBLY 517292</p> <p>Type: FOCUS Tube head Ser. No:</p> <p>Manufactured:</p> <p>Tube Type: D-0711S Tube Ser. No: 0.7 mm (IEC60336:1993) 70 Kv Maximum 840 mAs/h Total Filtration: 2.0 mm Al 70 kV</p> <p>This product complies with DHHS 21 CFR Chapter I, Subchapter J at the date of manufacture.</p> <p>Manufactured by Instrumentarium Dental, Nahkelantie 160, FI-04300 TUUSULA, Finland</p>
③	<p>WARNING: </p> <p><i>Voltagés inside this cover can be deadly. Peak voltage level normally exceeds 300V.</i></p> <p>ATTENTION:</p> <p><i>Les tensions à l'intérieur peuvent être mortelles. Tensions supérieures à 300V.</i></p> <p>51704</p>		
④	<p>FUSES/FUSIBLES 230V~5 AT 115V~8 AT</p> <p>WARNING:</p> <p><i>For continued protection against risk of fire, replace only with the same type and rating of fuses.</i></p> <p>ATTENTION:</p> <p><i>Pour assurer une protection continue contre le risque d'incendie utilisez uniquement un fusible de rechange de même type et de mêmes caractéristiques nominales</i></p> <p>Line impedance (max) 0.2 Ω Supply mains over-current releases: 115 – 230V: 16A</p> <p>213841 RT 51773</p>	⑤	<p>Warning: 76166</p> <p>This x-ray unit may be dangerous to patient and operator unless safe exposure factors, operating instructions and maintenance schedules are observed.</p> <p>Attention:</p> <p>Cet appareil à rayons X peut être dangereux pour l'opérateur et le patient à moins que des paramètres radiologiques adaptés soient utilisés et que les instructions d'utilisation et les plannings de maintenance soient observés.</p>
⑥	<p>Type: Focus Manufactured by Instrumentarium Dental This product complies with DHHS regulations Ser. No.: Nahkelantie 160 21 CFR Subchapter J applicable at date of manufacture. Manufactured: FI-04300 Tuusula, Finland Radiation area Ø 60 mm @ 22.9 cm (9 inch) SSD.</p> <p>51102</p>		

Labels on the picture are for reference purposes only. Actual texts may not be accurate.

1.7 Configurations

WARNING! USE LIMITATION: *The unit or its parts must not be changed or modified in any way without approval and instructions from the manufacturer.*

The use of accessories, transducers, and cables other than those specified may result in degraded ELECTROMAGNETIC COMPATIBILITY of the device.

WARNING! *If you suspect any electro-magnetical interference affecting or caused by the unit, call service. Portable and mobile RF communications equipment can interfere with operation of the medical electrical equipment.*

The unit is available with three different arm length configurations:

CONFIGURATION	HORIZONTAL ARM LENGTH	REACH
Short reach	50 cm	176 cm / 69 in
Medium reach	65 cm	191 cm / 75 in
Extra long reach	90 cm	216 cm / 85 in

Each unit is equipped with remote control with 32.8 feet (10m) 8 wire cable with RJ-45 plugs and Installation manual.

The unit is available with seven different cones, see chapter 2.2 Cones for cone illustrations:

CONES
Short cone, round (SSD 229 mm/9", Ø60 mm)
Short cone, rectangular, small (SSD 229 mm/9", 28x36 mm)
Short cone, rectangular (SSD 229 mm/9", 35x45 mm)
Long cone, round (SSD 305 mm/12", Ø60 mm)
Long cone, rectangular (SSD 305 mm/12", 35x45 mm)
Short cone, full metal, rectangular (SSD 229 mm/9", 35x45 mm)
Long cone, full metal, rectangular (SSD 305 mm/12", 35x45 mm)

The unit has two mounting options:

WALL MOUNT PLATES
Narrow wall mount plate
Wide wall mount plate

Following accessories are approved items, and they can be ordered separately.

ACCESSORIES
Short cone, round (SSD 229 mm/9", Ø60 mm)
Short cone, rectangular, small (SSD 229 mm/9", 28x36 mm)
Short cone, rectangular (SSD 229 mm/9", 35x45 mm)
Long cone, round (SSD 305 mm/12", Ø60 mm)
Long cone, rectangular (SSD 305 mm/12", 35x45 mm)
Short cone, full metal, rectangular (SSD 229 mm/9", 35x45 mm)
Long cone, full metal, rectangular (SSD 305 mm/12", 35x45 mm)
Short reach, 176 cm / 69 in
Medium reach, 191 cm / 75 in
Extra long reach, 216 cm / 85 in
Additional remote control panel (one unit can have up to two panels)
Remote exposure switch (one unit can have up to two switches)
Narrow wall mount plate
Wide wall mount plate

NOTICE! *To maintain safe and correct operation of the unit, only the approved accessories should be used. All the standard and optional items and approved accessories are suitable for use within the patient environment.*

1.8 Radiation protection guidelines

The unit emits X-ray radiation for medical purposes. The unit may cause an injury if used improperly. The instructions contained in this manual must be read and followed when operating the unit. All government and local regulations pertaining to radiation safety must be observed.

NOTICE for USA!

Many provisions of these regulations are based on recommendations of the National Council on Radiation Protection and Measurements. Recommendations for dental x-ray protection are published in NCRP Report #35 available from NCRP Publications, 7910 Woodmont Avenue, Suite 1016, Bethesda, MD 20814.

Personal radiation monitoring and protective devices are available and recommended for staff members. It is also recommended to provide the patient with a protective apron. Consult the physician before taking images of pregnant patients.

WARNING! *The unit must not be used in rooms where explosive hazards exist.*

Use the unit with radiation protection in accordance with IEC 60601-1-3 (and/or local requirements).

PROTECTION BY DISTANCE

In all examinations the user of the x-ray equipment should wear protective clothing. The operator does not need to be close to the patient during normal use. The protection against scatter radiation can be achieved by using the remote control or the remote exposure button not less than 7 feet (2 meters) from the focal spot and the x-ray beam. The cable length of the optional remote exposure button is approximately 32 feet (10 meters). The operator should maintain visible contact with the patient and technique factors. This allows immediate termination of radiation by the release of the exposure button in the event of a malfunction or disturbance.

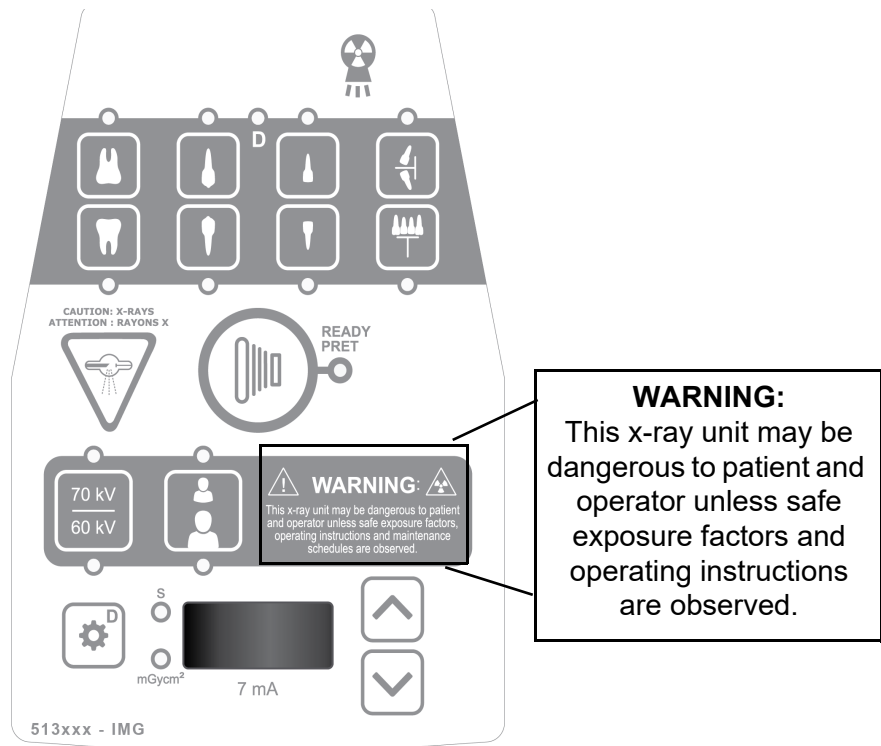

Caution information on remote control

1.9 Manufacturer's liability

As a manufacturer we can only assume liability of safe and reliable operation of this unit when:

- The unit installation was performed according to the Installation Manual supplied with the unit.
- The unit is used according to this User's Manual.
- Maintenance and repairs are performed by a qualified FOCUS™ intraoral x-ray dental dealer.
- Original or authorized spare parts are used.

If service on the unit is performed, a work order describing the type and extent of repair must be provided by the service technician. This must contain information of changes of nominal data or work range performed. The work order must furthermore indicate the date of repair, the name of the company concerned and a valid signature. User should keep this work order for future references.

1.10 Disposal

When the unit does no longer meet the manufacturer's intended operational specifications, despite proper maintenance and repair, then the unit is no longer serviceable and should be replaced. Follow all regulations on disposal of waste parts. The unit has at least the following parts that should be regarded as non-environmentally friendly waste products:

- X-ray source assembly
- All electronic circuits

2 Unit description

2.1 Main parts



1. Mounting system

Options:

- Narrow wall mount (default)
- Wide wall mount
- Adapter for KaVo treatment units

2. Connection box

- Mains wiring

3. Horizontal arm

Options:

- Short reach
- Medium reach
- Extra long reach

Includes an electronics module and internal cables

4. Scissors arm

Includes main cable and tube head arm

5. Tube head

6. Cone

Options:

- Short cone, round
- Short cone, rectangular
- Long cone, round
- Long cone, rectangular
- Short cone, full metal, rectangular
- Long cone, full metal, rectangular

7. Remote control panel

Includes a 10m cable and exposure button on the control panel

2.2 Cones

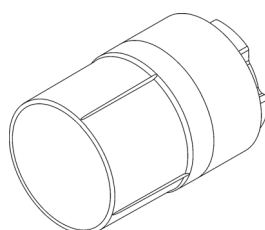

Short cone, round
SSD 229 mm/9", Ø60 mm

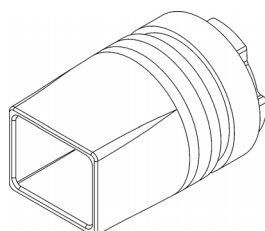

Short cone, rectangular
SSD 229 mm/9", 35x45 mm

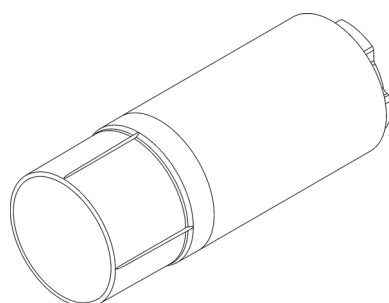

Long cone, round
SSD 305 mm/12", Ø60 mm

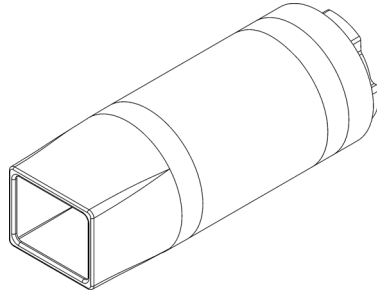

Long cone, rectangular
SSD 305 mm/12", 35x45 mm

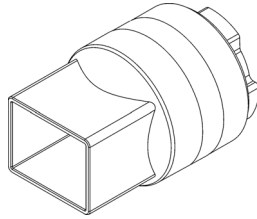

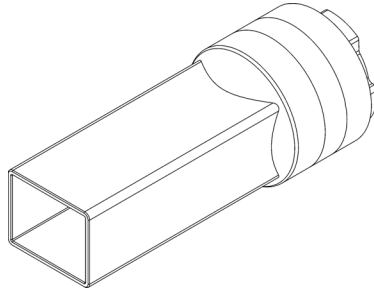

Short cone, full metal, rectangular
SSD 229 mm/9", 35x45 mm



Long cone, full metal, rectangular
SSD 305 mm/12", 35x45 mm

2.3 Symbols on remote control

	Maxillary molar
	Maxillary cuspid
	Maxillary incisors
	Bitewing
	Mandibular molar
	Mandibular cuspid
	Mandibular incisors
	Occlusal
	Exposure button
	X-ray source assembly: emitting
	Ready for exposure
	Patient Size Selection
	Digital mode selection
	Voltage selection, 60 or 70 kV
	Radiation warning
	Exposure time & DAP display



Exposure time control



3 Using the unit

3.1 Precautionary actions for safe use

Check that the installation site allows the unit to be set in all positions without making contact with any objects.

WARNING! *Proper grounding cannot be ensured unless the unit is connected to properly wired hospital grade outlet.*

WARNING! *If the patient is using a pacemaker, consult the manufacturer of the pacemaker before taking an exposure to confirm that the x-ray unit will not interfere with the operation of the pacemaker.*

WARNING! *Make sure that you don't touch the patient and any exposed electrical connectors simultaneously.*

3.2 Switching the power on/off

The power switch is located on the bottom of the access block. Turn the switch to the ON (I) position to switch the unit on. The green light indicator will illuminate. The system will reset and run a self-test.

The remote display will light up and read the previously used exposure time. Also, light indicators will illuminate representing the previously used values for the digital, Auto and kV selection.

The green READY light will illuminate when an exposure can be made.

To shut the unit down, turn the switch to the OFF position (O). For permanently installed units, this is the primary method of isolating the unit from mains supply.

WARNING! *Shut down the unit in case of errors or unexpected operation.*

3.3 Selecting the cone

Cone selection includes round or rectangular and short or long cones.

If a cone with different length from that set in the factory is needed, go to programming mode and select the desired cone length as described in the “*Program Mode*” section of this manual. Remove the cone by rotating it and pulling it out. Then push and rotate the new cone in.

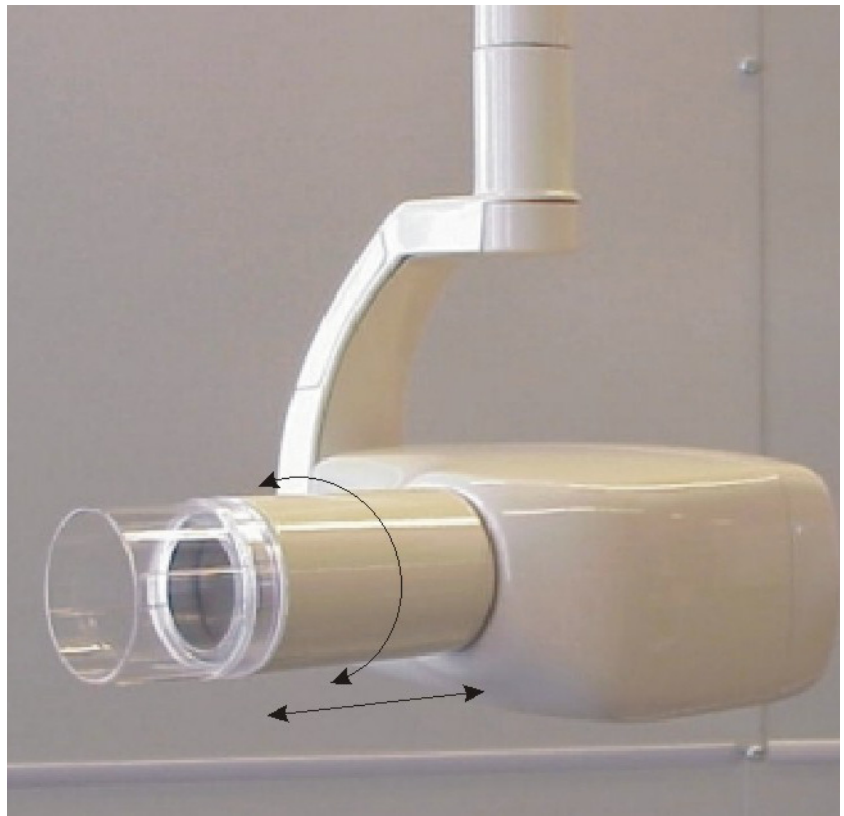

NOTICE! *Make sure that the values set in the programming mode correspond to the cone length and shape.*

3.4 Selecting the exposure parameters

1. Press the kV button to toggle between the two choices, 60 kV or 70 kV. The LED will indicate the selection.
2. Press the patient size button to toggle between the two choices, Adult and Pediatric. The adjacent light will indicate the selection.
3. Press the D button to select between Film and Digital mode. The light is ON in Digital mode.

CAUTION! *Assure that the right image capture unit mode (Film/Digital) is on.*

- 4.** Press one of the buttons representing the eight anatomical time settings (tooth buttons). The adjacent light indicator will illuminate corresponding to the selection. All other tooth button light indicators will be off.
- 5.** The exposure time may be adjusted manually with the UP and DOWN buttons. The exposure time is based on the tooth type, patient size, exposure mode (film or digital), value of kV, film speed and cone length. The exposure time is shown on the display to two decimal places. Whenever one of the determining parameters is changed, the value for the exposure time is recalculated and the display is updated.
- 6.** Close the door if a door switch is installed.

3.5 Positioning the patient

1. Set the patient's head into correct position according to selected imaging modality.
2. Place the film packet /sensor into the patient's mouth. Bring the tube head close to the patient's skin and aim the beam towards the film/sensor observing the correct angle of the beam. The horizontal angle of the cone is indicated on the scale located around the vertical joint of the tube head.

NOTICE! Always use disposable hygienic covers on the sensors or sterilize them before placing them on patient's mouth to prevent cross contamination.

Maxillary occlusal

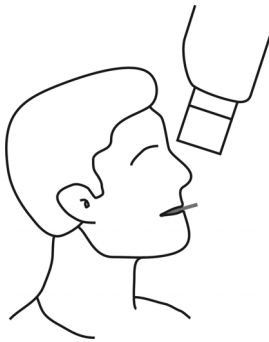

Maxillary anterior

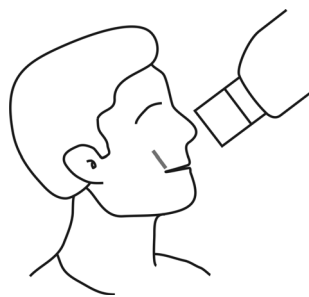

Maxillary molar

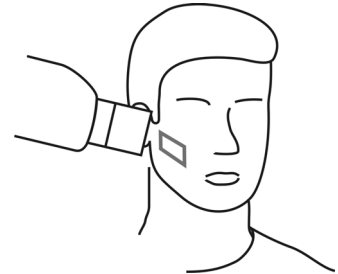

Mandibular occlusal

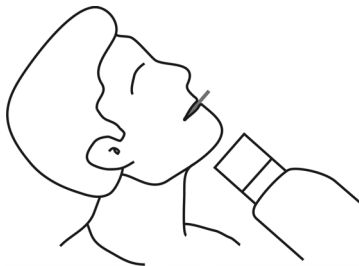

Mandibular anterior

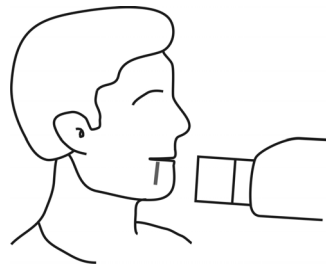

Mandibular molar

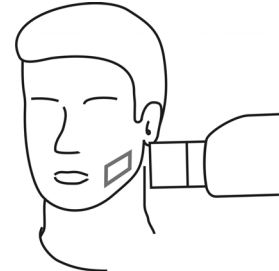

Mandibular canine

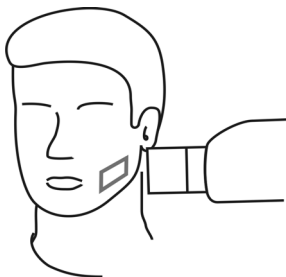

Bitewing

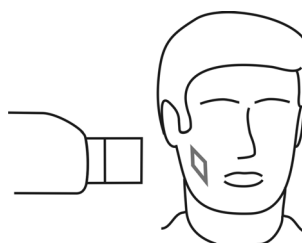

3. Use the focal length as long as possible to keep the absorbed dose as low as reasonably achievable.
4. Instruct the patient to avoid any movement during the exposures.

WARNING! *Take care not to hit the patient with the unit during the positioning of the patient.*

NOTICE! *If the resulting image isn't adequate, ensure that the patient positioning, the film/sensor positioning and the exposure values are correct for the wanted exposure.*

3.6 Taking an exposure

1. READY light will illuminate on the remote control when the unit is ready for exposure.
2. Use either the hand-held/wall external exposure switch or the exposure button on the remote control.
3. Press and hold the exposure button through the entire exposure cycle until the audible signal terminates.

During the exposure, the yellow warning light will illuminate and the beeper will be activated. These two actions will stop when the exposure is completed or if the exposure button is released prematurely. The exposure time display will go blank during the exposure and will reflect the elapsed time of the actual exposure afterwards.

NOTICE! *When using the system in an extremely high electromagnetic environment interferences may change image quality. If interference appears, contact your KaVo Dental dealer.*

3.7 Monitoring of dose levels



The calculated dose is displayed as the product of dose and beam area as measured by a dose area product (DAP) mGycm^2 and can be observed from the remote control panel.



To see the DAP value (mGycm^2) after an exposure, press the “digital mode” and “down” button simultaneously.

The DAP value is shown approx. 5 seconds while the mGycm^2 LED light is illuminated.

NOTICE! *The DAP value is depended on the selected cone. Before reading the DAP value, be sure that the right cone type is selected from program mode (see chapter 4).*

4 Default settings

4.1 Program mode

Enter or exit the program by pressing and holding the kV button for two seconds or more. The beeper will sound three times. No exposures may be taken while in the program mode. The READY light will be off.

The menu selections are scrolled with the UP and DOWN buttons. Enter or exit the selection by pressing the kV button. Data is edited with the UP button.

The program mode will exit automatically after it remains idle for 30 seconds. When control returns to the operating mode, the display will show the updated exposure time.

Menu Selections	Display Contents
Film Speed	Pr1
<i>fast film (Speed F)</i>	<i>SF</i>
<i>fast film (Ekta speed, E)</i>	<i>SE</i>
<i>slow film (Ultra speed, D)</i>	<i>Sd</i>
Cone selection	Pr2
<i>short round</i>	<i>1</i>
<i>short rectangular</i>	<i>2</i>
<i>long round</i>	<i>3</i>
<i>long rectangular</i>	<i>4</i>
<i>short rectangular for sensor size 1</i>	<i>5</i>
<i>short rectangular for sensor size 2</i>	<i>6</i>
Exposure Counter	Pr3
<i>First (0 - 999)</i>	<i>2 digits displayed</i>
<i>Second (1000 - 99000)</i>	<i>3 digits displayed</i>
AEC selection (NOT IN USE)	Pr4
<i>AEC selection ON</i>	<i>AEC</i>
<i>AEC selection OFF</i>	<i>---</i>
Set Factory Defaults, two beeps	Pr5
Speaker adjustment	Pr6
<i>speaker volume (1 = min. 8 = max.)</i>	<i>1-8</i>
DAP Cumulative Dose Area Product	Pr7
<i>to reset cumulative counter, press D</i>	
Sensor type selection*	Pr8
<i>intraoral x-ray sensor (default)</i>	<i>GEN</i>
<i>(alternative intraoral sensor)</i>	<i>SIG</i>

Menu Selections		Display Contents
	<i>Phosphor Plate</i>	<i>PHO</i>
Preheat boost adjustment		Pr9
	(On, if generator revision 1.x)	<i>On</i>
	(Disabled, if generator revision 2.x)	<i>DIS</i>

* Different exposure times can be programmed for each sensor type (similar way as described in 4.1 Programmable anatomical time settings)

4.2 Programmable anatomical time settings

The anatomical time settings (tooth buttons) have been preprogrammed by the factory but can be changed if necessary by the user.

First increase or decrease the exposure time with UP and DOWN buttons. Then press and hold the corresponding tooth button for two seconds or more. The beeper will beep two times. The new time setting is now saved into the memory.

5 Error messages

The error messages are grouped into two categories. User errors (H) and system fault errors (E). User errors must either be acknowledged or it will be removed once the error is corrected. When system faults occur, a service technician should be contacted.

Display Contents	Error or Failure	Action
E1	KV failure	Contact the service
E2	MA failure	Contact the service
E3	PREH failure	Contact the service
E4	Tube head too hot or too cold	Wait for valid tube head temperature
E5	Line voltage low	Contact the service
E6 (not in use)	N/A	Contact the service
E7	EEPROM failure	Contact the service
H1(necessary waiting time)	Duty cycle	Wait for tube to cool
H2(flashes alternately with elapsed exposure time)	Premature button release	Acknowledge with UP or DOWN button
H3	Door switch open (connected to Adjustment part)	Check that door is closed
H4	Door switch open (connected to Remote Control Panel)	Check that door is closed
H5	System in Service mode	Go to the user mode
H6 (NOT IN USE)	NA	NA
H7 (NOT IN USE)	NA	NA

6 Maintenance

6.1 Cleaning

The cone should be cleaned after every patient usage. Items and surfaces that are not given special instructions for cleaning, disinfecting and sterilizing, can be cleaned with a soft cloth moistened with a suitable disinfectant after each usage.

WARNING! *Always disconnect the unit from the power supply or switch off the power prior to cleaning or disinfecting the unit. Do not allow any liquid to enter the unit interior.*

CAUTION! *Do not allow water or other cleaning liquids to enter the unit interior since these may cause damage.*

Use a cloth moistened in cool-to-lukewarm, soapy water to clean the unit, and prevent coagulation and thus facilitate the removal of protein substances. Then wipe with a cloth moistened in clear water. Mild detergent solution can be used. Never use solvents of any kind. If you are uncertain of the nature of cleaning agent, do not use it.

For example, the following cleaning agents are allowed (and not allowed) to clean the unit panels:

Allowed:

Soap, Butylalcohol, Ethanol (ethyl alcohol) 96%, Methanol (methyl alcohol).

Not allowed:

Benzene, all chlorine solutions, Phenol, Acetone, Acetic ether

6.2 Disinfecting

Use Ethanol 96% for disinfecting of equipment. Wipe manually with clean cloth moisturized in disinfectant solution. Never use corrosive or solvent disinfectants. All items and surfaces should be dried before next usage.

NOTICE! *Wear gloves and other protective gear during disinfecting process.*

WARNING! *Do not use any disinfecting sprays since the vapor could ignite causing injury.*

Disinfecting techniques for both the unit and the room must comply with all laws and regulations that have jurisdiction within which the unit is located.

6.3 Periodic maintenance

This unit is designed to provide reliable performance and many years of customer satisfaction. In order to assure safe performance, the unit must be checked by a qualified service technician. The time of service depends on the usage of the unit and so it is the user's responsibility to estimate the need for service. It is the owner's responsibility to supply or arrange for this service. Consult your authorized dealer for such service. In addition to periodic maintenance any deviation from normal performance should be immediately reported to your dealer.

WARNING! *Only trained and qualified personnel should be permitted to access the internal parts of the unit.*

CAUTION! *After the operation in the service mode the unit must be switched off.*

The user should perform the following inspections on a monthly basis:

- Visually check that all visible labels are intact and legible
- Check that the power supply cable is properly attached to the mains socket and visually check the cable for damage. If the cable is damaged, it shall be replaced by authorized service technician only.
- Visually check that the exposure indicator light illuminates for the duration of exposure
- Confirm that the audible indicator beeps for the duration of the exposure
- Check that exposure button must be kept pressed continuously during the exposure cycle
- Check that exposure terminates when the exposure button is prematurely released
- Check all the functions of the remote control.

6.4 Radiation dose measurement

If the user wants to periodically measure and follow the radiation dose consistency, it can be measured in the following way.

Use test object (6mm thick aluminum sheet, or other object with filtration equivalent to 6mm Al) to represent a normal patient, place a radiation detector (not supplied with the unit) on the test object and position the cone of the unit on the radiation detector.

Recommended technique factors for conducting this test are: 70 kV, 0.2s exposure time.

Expected dose using this method is found in DOSE AREA PRODUCT table in chapter 7. The measured dose depends on the cone used, variations between units, radiation detector accuracy, etc.

NOTICE! *Measured dose is an estimate of patient entrance dose.*

Increasing technique factor values (kV, s) increases the exposure dose.

6.5 Changing the fuses



The fuses are located next to the mains switch on the bottom of the access block.

Push inward on the fuse base and twist it counterclockwise with a screwdriver. The fuse with the base will come out.

Remove the fuse from the base and replace it with the new one. Repeat this with each blown fuse. Fasten both fuses by pushing the base in and twisting it clockwise with a screwdriver.

WARNING! *Replace the fuses only with fuses of the same type and rating.*

7 Technical data

7.1 Technical specifications

Manufacturer:	Instrumentarium Dental, PaloDEX Group Oy, Nahkelantie 160 FI-04300 Tuusula, FINLAND
Manufacturer's Quality System:	In accordance with ISO13485 and ISO9001 standard
Environmental Management System:	In accordance with ISO 14001 standard
Conformity to standards:	IEC 60601-1 IEC 60601-1-4 IEC 60601-1-3 IEC 60601-2-7 IEC 60601-2-28 IEC60601-2-65 CAN/CSA –C22.2 No. 601-1-M90 CE models marked according to the Medical Device Directive 93/42/ EEC

Product Name	FOCUS™ intraoral x-ray
Type	FOCUS

UNIT DATA	
Protection against electric shock	Class I
Degree of protection	Type B
Protection against the ingress of liquids	IP20
Mode of operation	Continuous operation with intermittent loading
Power supply	Mains connection, plug or fixed
Software version	3.0 or higher

X-RAY GENERATOR	
Generator type	Constant potential
Nominal power	490 W
High voltage	DC
Supply frequency	100-200 kHz
Number of phases	1
Reference current time product	7 mAs (70 kV, 7 mA, 1 s)
Lowest current time product	0.14 mAs (70 kV, 7 mA, 0.02 s)
Coefficient of variation of DAP	< 0,05

DENTAL CARE UNIT MOUNT MODEL DEVICE	
Horizontal arm length	330 mm (from axl to axl), 418 mm (total length)
Generator module length	500 mm
Horizontal arm shaft diameter	32 mm
Main cable length	5230 mm (measured from generator module to the scissors arm)

TUBE HEAD ASSEMBLY	
Tube head assembly type	THA-I
Tube type	D-0711SB or Kailong KL 21 SB or equivalent
Max. tube voltage	60 or 70 kV
Max. tube current	7 mA
Max. electric output	490 W (70kV; 7mA)
Reference axis	Runs axially with the cone
Target angle	16 degrees
Focal spot	0.7 mm (according to IEC 60336/2005)
Nominal anode input power	940 W
Max. symmetrical radiation field	Ø60 mm at a 200 mm focal length
Total filtration	2,0 mm Al (70 kV)
Inherent filtration	1 mm Al (70 kV)
Fixed additional filtration	1,0 mm Al (70 kV)
Max. anode heat content	7 kJ
Maximum X-ray tube assembly heat content	140 kJ
Maximum continuous heat dissipation of the X-ray tube head assembly	19 W

ELECTRICAL CONNECTIONS	
Nominal mains voltage	115 VAC +/- 10% 230 VAC +/- 10%
Input power frequency	60 Hz 50 Hz
Nominal current	7.63A 3.55A
Mains fuse, slow blow	6.25AT
Apparent resistance of supply mains	0.68Ω
Power consumption	816 VA / 230 VAC 877 VA / 115 VAC
US/Canada mains connector type	115 V / NEMA 6-15P or similar
Power supply cords type	H05VV5-F / AWG 14 (UL 2587)

Nominal Shortest Irradiation Time	0.02 S
Exposure Time Range	0.02 - 3.2 S
Exposure Time Range In Aec Mode	0.02- 1.6 S

BEAM LIMITING DEVICE	
Cone dimensions	Round: Ø60 mm
	Rectangular: 35x45 mm / 28x36 mm

PHYSICAL MEASURES AND AMBIENT TEMPERATURES:	
Focal length (Standard/Long)	229 mm (9") / 305 mm (12")
Installation	Standard wall mount Optional base for free standing unit
Height x Width x Depth (mm)	Unit: 1059 mm x 279 mm x 946/1096/1346 mm Tube head assembly: 112 mm x 260 mm x 201 mm
Weight	Unit: approximately 30 kg (66 pounds) Tube head assembly: approximately 4.5 kg (10 pounds)
Type and length of the cable of the remote exposure switch	Length approximately 10 m (32.5 feet), RJ-45 plug at both ends (8 wires)
Transportation and Storage	-40°...+70°C (-40F...+158F), RH 10...100%
Operating environment	+10°...+40°C (+50F...+104F), RH max. 70%, 700 – 1060 mbar

DOSE AREA PRODUCT (DAP)								
kVp corrected DAP								
	Short cone, round (229 mm / 9")		Long cone, round (305 mm / 12")		Short cone, rectangular (229 mm / 9")		Long cone, rectangular (305 mm / 12")	
	60kV	70kV	60kV	70kV	60kV	70kV	60kV	70kV
set exposure time (s)	DAP mGycm ²	DAP mGycm ²	DAP mGycm ²	DAP mGycm ²	DAP mGycm ²	DAP mGycm ²	DAP mGycm ²	DAP mGycm ²
0,020	2,9	3,8	1,8	2,2	1,6	2,1	1,0	1,2
0,025	3,7	5,0	2,3	2,8	2,1	2,8	1,3	1,6
0,032	4,9	6,6	2,9	3,7	2,7	3,7	1,6	2,1
0,040	6,2	8,3	3,6	4,7	3,5	4,6	2,0	2,6
0,050	7,8	10,4	4,6	6,3	4,4	5,8	2,6	3,5
0,063	9,9	13,2	5,8	7,5	5,5	7,4	3,2	4,2
0,080	12,7	16,9	7,4	9,5	7,1	9,4	4,1	5,3
0,100	15,9	21,3	9,2	12,1	8,9	11,9	5,1	6,7
0,125	20,0	26,8	11,5	15,1	11,1	14,9	6,4	8,4
0,160	25,8	34,5	14,7	19,9	14,4	19,2	8,2	11,1
0,200	32,4	43,2	18,4	24,8	18,0	24,1	10,2	13,8
0,250	40,5	54,4	23,0	30,5	22,6	30,3	12,8	17,0
0,320	52,1	69,7	29,4	38,9	29,0	38,9	16,4	21,7
0,400	65,2	87,4	36,7	48,9	36,3	48,7	20,5	27,2
0,500	81,7	109,7	45,9	61,1	45,5	61,1	25,6	34,1
0,630	103,0	138,1	57,8	77,1	57,4	76,9	32,2	42,9
0,800	130,7	175,5	73,2	97,7	72,8	97,8	40,8	54,4
1,000	163,2	219,4	91,5	122,1	90,9	122,2	51,0	68,0
1,250	204,0	274,2	114,5	152,8	113,6	152,8	63,8	85,1
1,600	260,7	350,5	146,5	196,2	145,3	195,3	81,6	109,3
2,000	325,5	437,3	182,7	246,3	181,3	243,7	101,8	137,2
2,500	405,7	546,7	228,1	308,1	226,0	304,6	127,1	171,7
3,200	518,5	697,1	291,2	393,2	288,9	388,4	162,3	219,1

The displayed DAP value is calculated by scaling a measured DAP (default) value according to the used exposure factors and cones.

The equation for the DAP calculation is:

$$\text{DAP} = A * (\text{kV correction factor}) * \text{Default Dose} * \text{exposure time (seconds)},$$

where

'A' corresponds the selected cone (dose area).

'kV correction factor' is dependent on the selected kV

'Default dose' is the dose measured for 70kV, 7mA and 1 s exposure.

Any indicated DAP value is scaled from a dose that was measured for 70kV, 7mA, 1 second exposure.

7.2 EMC declaration

NOTICE! Medical electrical equipment needs special precautions regarding EMC and needs to be installed according to EMC information.

IEC60601-1-2 ed4 testing has verified that electromagnetic interference stimulus has no effect to safety critical functionality of the device. This includes the patient positioning and other imaging pre-conditions, imaging program value selection and imaging process

If abnormal performance is observed, such as degradation of essential performance in form of reduction of line pair resolution, additional measures may be necessary, such as re-orienting or relocating the device.

The device is suitable for use in both at professional healthcare (hospitals/large clinics) facility environment and home healthcare (clinics in domestic establishments and those directly connected to the public low-voltage power supply) environment.

Exceptions for professional healthcare facility environment: Not to be used or installed near active HF SURGICAL EQUIPMENT and the RF shielded room of an ME SYSTEM for magnetic resonance imaging, where the intensity of EM DISTURBANCES is high.

Table 1: Electromagnetic emissions IEC 60601-1-2 Ed4

The device is suitable for use in the specified electromagnetic environment. The purchaser or user of the device should assure that it is used in an electromagnetic environment as described below:		
Emissions Test	Compliance	Electromagnetic Environment
Radio-Frequency Emissions CISPR11	Group 1	The device uses RF energy only for its internal function. Therefore, the RF emission is very low and not likely to cause any interference in nearby electronic equipment.
Radio-Frequency Emissions CISPR11	Class B	The device is suitable for use in both at professional healthcare (hospitals/large clinics) facility environment and home healthcare (clinics in domestic establishments and those directly connected to the public low-voltage power supply) environment.
Harmonic emissions IEC61000-3-2	IEC61000-3-2 Class A	
Voltage fluctuations/ flicker emissions IEC61000-3-3	Complies	Exceptions for professional healthcare facility environment : Not to be used or installed near active HF SURGICAL EQUIPMENT and the RF shielded room of an ME SYSTEM for magnetic resonance imaging, where the intensity of EM DISTURBANCES is high.

Table 2: Electromagnetic immunity IEC 60601-1-2 Ed4

The device is suitable for use in the specified electromagnetic environment. The purchaser or user of the device should assure that it is used in an electromagnetic environment as described below:			
Immunity Test	IEC60601-1-2 Test Level	Compliance Level	Electromagnetic Environment
Electrostatic discharge (ESD) IEC61000-4-2	± 8 kV for contact discharge ±2, 4, 8, 15 kV for air discharge	± 8 kV for contact discharge ±2, 4, 8, 15 kV for air discharge	Floors are wood, concrete, or ceramic tile, or floors are covered with synthetic material and the relative humidity is at least 30 percent.
Electrical fast transient/burst IEC 61000-4-4	±2 kV for power supply lines (100 kHz) ±1 kV for input/output lines (100kHz)	±2 kV for power supply lines ±1 kV for input/output lines	Mains power quality is that of a typical commercial and/or hospital environment
Surge IEC61000-4-5	± 0.5, 1 kV differential mode ± 0.5, 1, 2 kV common mode	± 0.5, 1 kV differential mode ± 0.5, 1, 2 kV common mode	Mains power quality is that of a typical commercial and/or hospital environment.
Voltage dips, short interruptions and voltage variations on power supply input lines IEC61000-4-11	-0 % U mains; 0,5 cycle At 0°, 45°, 90°, 135°, 180°, 225°, 270° and 315° -0 % U mains; 1 cycle, At 0° -70 % U mains; 25/30 cycles At 0° -0 % U mains; 250/300 cycle At 0°	-0 % U mains; 0,5 cycle At 0°, 45°, 90°, 135°, 180°, 225°, 270° and 315° -0 % U mains; 1 cycle, At 0° -70 % U mains; 25/30 cycles At 0° -0 % U mains; 250/300 cycle At 0°	Mains power quality is that of a typical commercial and/or hospital environment. If the user of the device requires continued operation during power mains interruptions, it is recommended that the device is powered from an uninterruptible power supply.
Power frequency (50/60Hz) magnetic field IEC 61000-4-8	30A/m	30 A/m	Power frequency magnetic fields are at levels characteristic of a typical location in a typical commercial and/ or hospital environment. The device shall not be used closer than 15cm to sources of 50/ 60Hz magnetic field.
<i>NOTICE!</i> U_T is the a.c. mains voltage prior to application of the test level.			

Table 3: RF immunity of non-life-support equipment or system IEC 60601-1-2 ed.4

The device is suitable for use in the specified electromagnetic environment. The purchaser or user of the device should assure that it is used in an electromagnetic environment as described below:			
Immunity Test	IEC60601-1-2 Test Level	Compliance Level	Electromagnetic Environment
Conducted RF IEC 61000-4-6	3V 150kHz to 80 MHz, 6 V in ISM and amateur radio bands between 0,15 MHz and 80 MHz according to table 60601-1-2. Ed4. Table 5/8.	3V 150kHz to 80 MHz, 6 V in ISM and amateur radio bands between 0,15 MHz and 80 MHz according to table 60601-1-2. Ed4. Table 5/8.	Portable and mobile RF communications equipment are used no closer to any part of the device including cables, than the recommended separation distance calculated from the equation appropriate for the frequency of the transmitter.
Radiated RF IEC 61000-4-3	10 V/m 80 MHz to 2,7 GHz Immunity to proximity fields from RF wireless communication equipment, levels according to table 60601-1-2 ed4 table 9.	10 V/m 80 MHz to 2,7 GHz Immunity to proximity fields from RF wireless communication equipment, levels according to table 60601-1-2 ed4 table 9.	<p>Recommended Separation Distance:</p> $d = 2\sqrt{P} \quad 150\text{kHz}-80\text{MHz}$ $d = 0,6\sqrt{P} \quad 80\text{MHz to } 800 \text{ MHz}$ $d = 0,6\sqrt{P} \quad 800 \text{ MHz to } 2,7 \text{ GHz}$ <p>Where P is the maximum output power rating of the transmitter in watts (W) according to the transmitter manufacturer and d is the recommended separation distance in meters (m). Field strengths from fixed RF transmitters, as determined by an electromagnetic site survey,* are less than the compliance level in each frequency range.**</p> <p>Interference may occur in the vicinity of equipment marked with the following symbol:</p> 

Table 3: RF immunity of non-life-support equipment or system IEC 60601-1-2 ed.4

The device is suitable for use in the specified electromagnetic environment. The purchaser or user of the device should assure that it is used in an electromagnetic environment as described below:

* Field strengths from fixed transmitters, such as base stations for cellular telephones and land mobile radios, amateur radio, AM and FM radio broadcast, and TV broadcast cannot be estimated accurately. To assess the electromagnetic environment due to fixed RF transmitters, an electromagnetic site survey should be performed. If the measured field strength exceeds the RF compliance level above, observe the device to verify normal operation in each use location. If abnormal performance is observed, additional measures may be necessary, such as re-orienting or relocating the device.

Guidance for actions taken can be found from AAMI TIR 18:2010, Guidance on electromagnetic compatibility of medical devices in healthcare facilities.

NOTICE! *Precautions to take if the use location is near (e.g. less than 1,5 km from) AM, FM or TV broadcast antennas.*

** Over the frequency range 150 kHz to 80 MHz, field strengths are less than 3 V/m. **The Recommended Separation Distances are listed in the next table.**

NOTICE! *These guidelines may not apply in all situations. Electromagnetic propagation is affected by absorption and reflection from structures, objects, and people.*

NOTICE! *RF communications equipment can effect medical electrical equipment.*

Table 4: Separation distances

Recommended Separation Distances for Portable and Mobile RF Communications Equipment IEC 60601-1-2			
The device is intended for use in an electromagnetic environment in which radiated RF disturbances are controlled. The user of the device can help prevent electromagnetic interference by maintaining a minimum distance between portable and mobile RF communications equipment (transmitters) and the device as recommended below, according to the maximum output power of the communications equipment.			
Frequency of Transmitter	150 kHz to 80 MHz	80 MHz to 800 MHz	800 MHz to 2.7 GHz
Equation	$d = 2\sqrt{P}$	$d = 0,6\sqrt{P}$	$d = 0,6\sqrt{P}$
Rated Maximum Output Power of Transmitter (watts)	Separation Distance (meters)	Separation Distance (meters)	Separation Distance (meters)
0,01	0,20***	0,06***	0,06***
0,1	0,63	0,19***	0,19***
1	2	0,6	0,6
10	6,32	1,90	1,90
100	20	6	6
For transmitters rated at maximum output power not listed above, the recommended separation distance d in meters (m) can be estimated using the equation applicable to the frequency of the transmitter, where P is the maximum output power rating of the transmitter in watts (W) according to the transmitter manufacturer.			
NOTICE! At 80 MHz, the separation distance for the higher frequency range applies.			
NOTICE! These guidelines may not apply in all situations. Electromagnetic propagation is affected by absorption and reflection from structures, objects, and people.			
WARNING! *** Portable RF communications equipment (including peripherals such as antenna cables and external antennas) should be used no closer than 30 cm (12") to any part of the device, including cables specified by the manufacturer. Otherwise, degradation of the performance of this equipment could result.			

USE LIMITATION:

External components

WARNING! Use of accessories, transducers and cables other than those specified or provided by the manufacturer of this equipment could result in increased electromagnetic emissions or decreased electromagnetic immunity of this device and result in improper operation.

INSTALLATION REQUIREMENTS & ENVIRONMENT CONTROL:

In order to minimize interference risks, the following requirements shall apply.

Cables shielding & grounding

All interconnect cables to peripheral devices must meet the requirements given in Technical specifications. Use of incorrect cables may result in the device causing radio frequency interference.

Electrostatic discharges environment & recommendations

In order to reduce electrostatic discharge interference, a charge dissipative floor should be installed to prevent charge accumulation.

- The dissipative floor material must be connected to the system reference ground, if applicable.
- Relative humidity must be maintained above 30 percent.

Stacked components & equipment

WARNING! *The device should not be used adjacent to or stacked with other equipment; if adjacent or stacked use is necessary, the device should be observed to verify normal operation in the configuration in which it will be used.*

Interference may occur in the vicinity of equipment marked with the following symbol:



8 User's statement

Instructions for the use of the unit and precautionary statements are part of the unit *User's Manual*.

RADIATION LEAKAGE TECHNIQUE FACTORS

The maximum-rated peak tube potential is 70 kVp with the maximum rated continuous tube current of 1.5 mA.

BEAM LIMITING DEVICE / TUBE HOUSING ASSEMBLY COMPATIBILITY

The tube housing assembly THA-I is compatible with the beam limiting device.

Art.No	Part number	Cones	Program Mode Pr2 Cone type ID
0.805.0057	50410-img	Long cone, round SSD 305 mm/12", Ø60 mm	3
0.805.0058	50420-img	Long cone, rectangular SSD 305 mm/12", 35x45 mm	4
0.805.0059	50540-img	Short cone, round SSD 229 mm/9", Ø60 mm	1
0.805.0060	50550-img	Short cone, rectangular SSD 229 mm/9", 35x45 mm	2
0.805.0061	50551-img	Short cone, rectangular, small SSD 229 mm/9", 28x36 mm	5
0.805.0062	50720-img	Long cone, full metal, rectangular SSD 305 mm/12", 35 x 45 mm	4
0.805.4235	50750-img	Short cone, full metal, rectangular SSD 229 mm/9", 35 x 45 mm	6

EQUIPMENT STATEMENT FOR TUBE HOUSING ASSEMBLY

Maximum operating voltage is 70 kVp. Nominal focal spot is 0.7 mm.

X-ray tube: D-0711SB or D-0711S. For additional information please refer to the tube specification sheets.

MAXIMUM DEVIATION FROM INDICATED VALUES

PARAMETER	INDICATED VALUE	DEVIATION
Tube voltage	60 - 70 kVp	± 4%
Tube current	7 mA	± 10%
Exposure time	0.02 - 3.2 s	(± 10% + 1ms)
Dose Area Product	1.0 - 697.1 mGycm ²	± 50%

POWER SUPPLY REQUIREMENTS

Rated nominal voltage 115 / 230 VAC, 60 / 50 Hz single phase. Line voltage range is 115 ± 10% and 230 ±10% VAC. Automatic regulation for all voltages within the line voltage range.

WARNING! *To avoid the risk of electric shock, the unit must only be connected to a supply mains with protective earth. Proper grounding cannot be ensured unless the unit is connected to properly wired hospital grade outlet.*

WARNING! *If the unit needs to be connected to a multiple socket outlet, it shall not be placed on the floor.*

WARNING! *Multiple extension cables shall not be used.*

WARNING! *The x-ray unit must be connected to it's own separate power supply. PC or any other external units must NOT be connected to the same power supply as the x-ray unit.*

MAXIMUM LINE CURRENT

With 115 VAC power supply systems the maximum line current during the exposure is 8 A, at stand by maximum 0.2 A. The system line fuses are 6.25 A slow blow type.

With 230 VAC power supply systems the maximum line current during the exposure is 5 A, at stand by maximum 0.1 A. The system line fuses are 6.25 A slow blow type.

TUBE RATINGS, TUBE HEAD COOLING CURVE

MAXIMUM RATING CHARTS
(ABSOLUTE MAXIMUM RATING CHARTS)

DC

FOCAL SPOT : 0.7 mm

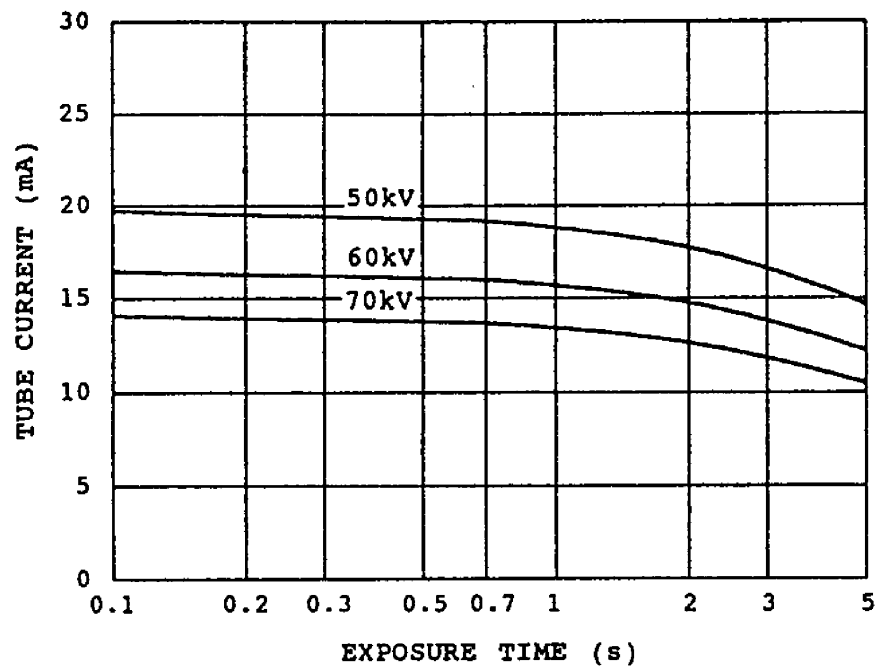

Fig 8.1. Maximum Rating Chart (D-0711SB or D-0711S)

ANODE THERMAL CHARACTERISTICS

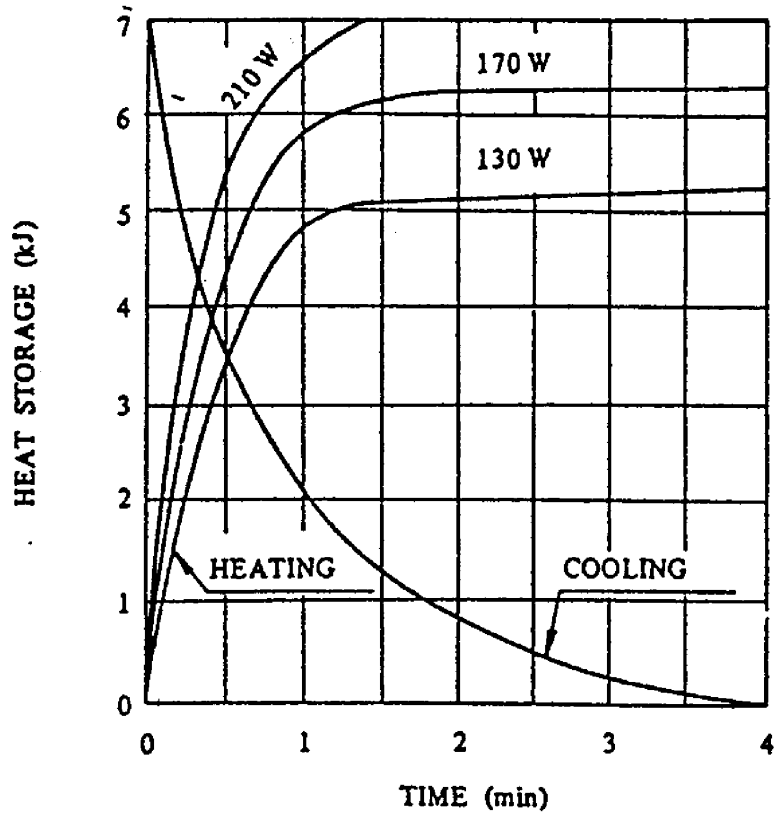

Fig 8.2. Tube anode thermal characteristics (D-0711SB or D-0711S)

TUBE HEAD THERMAL CHARACTERISTICS

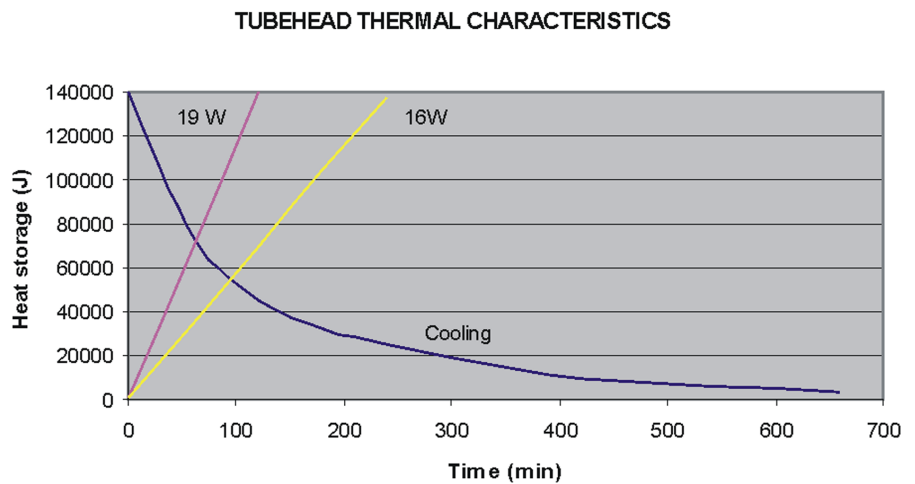

Fig 8.3. Tube head assembly cooling curve

WAIT TIMES BETWEEN EXPOSURES

Below are the wait times for different exposures.

Exp. time	Wait time	Exp. time	Wait time
0.02s	10s	0.32s	10s
0.03s	10s	0.40s	10s
0.04s	10s	0.50s	10s
0.05s	10s	0.63s	19s
0.06s	10s	0.80s	24s
0.08s	10s	1.00s	30s
0.10s	10s	1.25s	50s
0.12s	10s	1.60s	64s
0.16s	10s	2.00s	80s
0.20s	10s	2.50s	100s
0.25s	10s	3.20s	128s

DIMENSIONAL OUTLINE OF THE TUBEHEAD

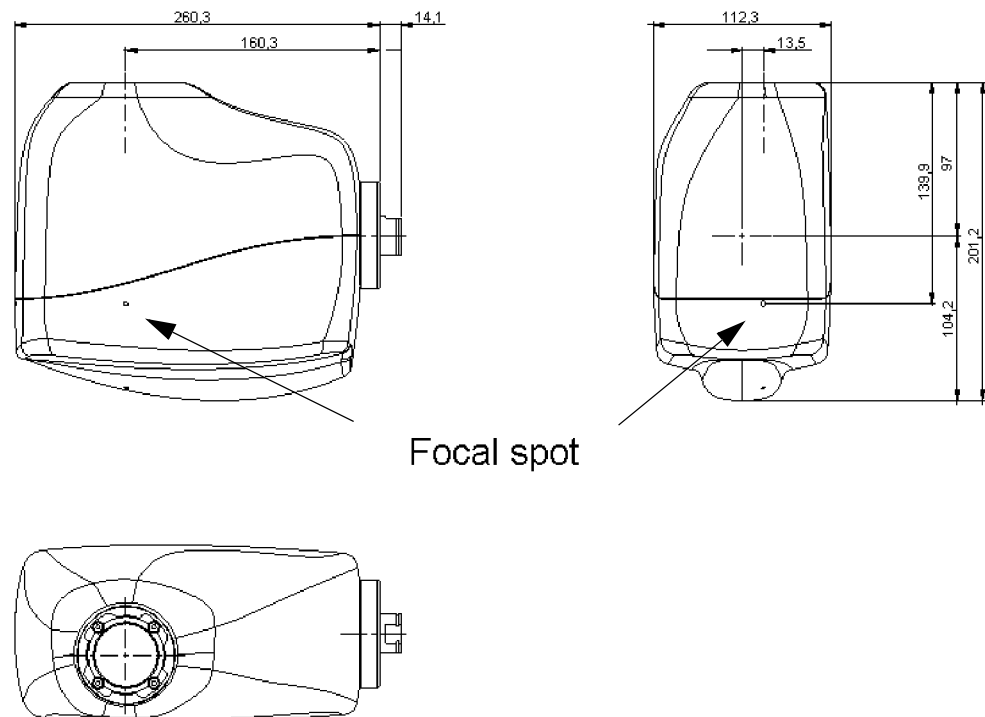

Fig 8.4. Tubehead dimensions and the location of the focal spot

NOTICE! Wiring diagrams, schematics, and other documents which are needed for repairing the unit, will be supplied on request.

MEASUREMENT CRITERIA FOR LOADING FACTOR CONDITIONS

Exposure time

Exposure time consists of beginning and ending points as measured by a calibrated x-ray monitor at 70% of the peak radiation waveform.

kVp

The high voltage peak value measured over the high voltage feedback resistor with a calibrated voltage device.

mA

The tube current mean value calculated by dividing the voltage over the feedback resistor value. The voltage is measured with a calibrated voltage device.

The nominal x-ray voltage 70kV is obtained at highest tube current 7mA.

The nominal tube current 7mA is obtained at the highest tube voltage 70kV.

The max. electric output is obtained at 70 kV tube voltage and 7 mA tube current.

The nominal power/exposure: 490 W

The manufacturer reserves the right to make technical changes at any time.

9 Recommended exposure times

Recommended exposure times with digital sensors and phosphor plates. These are also factory pre-set default values.

	60kV, 7mA				70kV, 7mA			
	9" cone		12" cone		9" cone		12" cone	
	Adult	Child	Adult	Child	Adult	Child	Adult	Child
Bitewing	0,250	0,160	0,500	0,320	0,125	0,080	0,250	0,160
Maxillary incisor	0,200	0,125	0,400	0,250	0,100	0,063	0,200	0,125
Maxillary cuspid	0,250	0,160	0,500	0,320	0,125	0,080	0,250	0,160
Maxillary molar	0,320	0,200	0,500	0,400	0,160	0,100	0,320	0,200
Occlusal	0,250	0,160	0,500	0,320	0,125	0,080	0,250	0,160
Mandibular incisor	0,200	0,125	0,400	0,250	0,100	0,063	0,200	0,125
Mandibular cuspid	0,250	0,160	0,500	0,300	0,125	0,080	0,250	0,160
Mandibular molar	0,250	0,160	0,500	0,320	0,125	0,080	0,250	0,160

Recommended exposure times with film (F-speed)

	9" cone			
	60kV		70kV	
	Adult	Child	Adult	Child
Bitewing	0,320	0,200	0,160	0,100
Maxillary incisor	0,250	0,160	0,125	0,080
Maxillary cuspid	0,320	0,200	0,160	0,100
Maxillary molar	0,400	0,250	0,200	0,125
Occlusal	0,320	0,200	0,160	0,100
Mandibular incisor	0,200	0,125	0,100	0,063
Mandibular cuspid	0,250	0,160	0,125	0,080
Mandibular molar	0,250	0,160	0,125	0,080

PaloDEX Group Oy reserves the right to make changes in specification and features shown herein, or discontinue the product described at any time without notice or obligation. Contact your PaloDEX Group Oy representative for the most current information.

Copyright © by PaloDEX Group Oy. All rights reserved.

216457-1

Headquarters

PaloDEX Group Oy | Nahkelantie 160 | P.O. Box 20
FI-04301 Tuusula | FINLAND | Tel. +358 10 270 2000
Email: info@instrudental.com
www.kavokerrgroup.com

USA

Instrumentarium Dental | 11727 Fruehauf Drive | Charlotte, NC
28273 | U.S.A
Tel. 800-558-6120 | Fax. 877-292-6050
Email: KKG.Imaging.CS@kavokerrgroup.com

KAVO
Dental Excellence