

EN

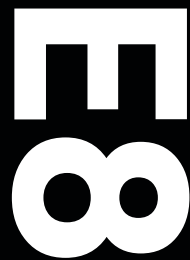

Euronda[®]

Pro System



State of the art
sterilisation,
for everyone.

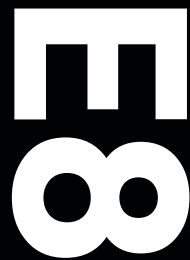

Euronda Pro System

Products, Process, Protection

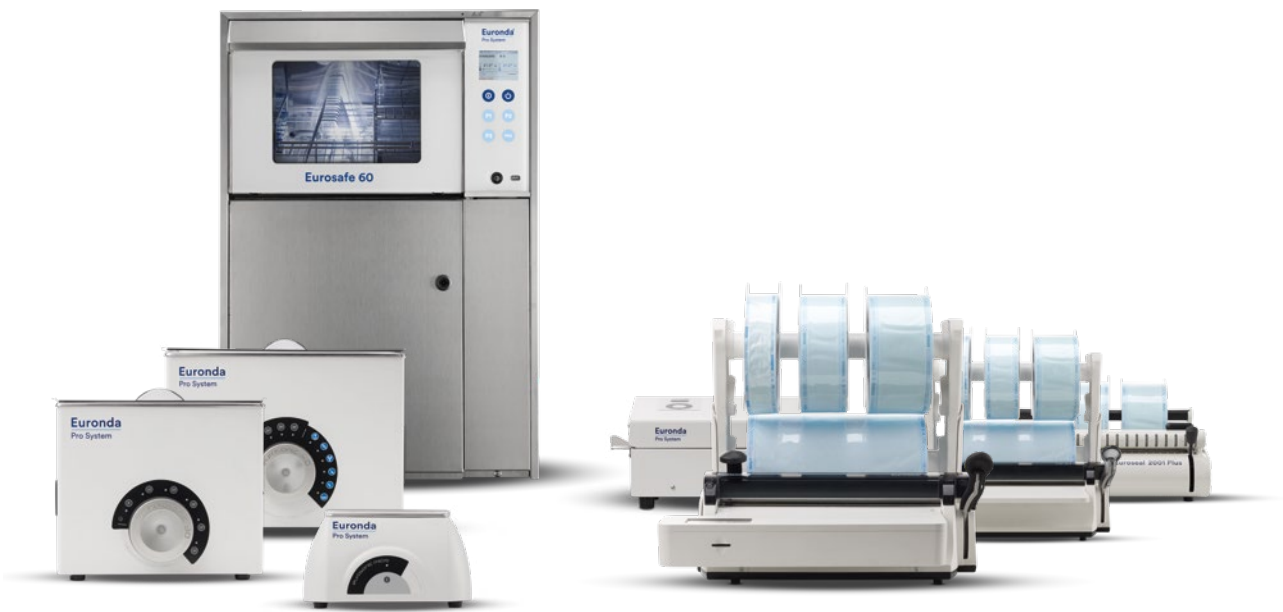

Cleaning

Packing

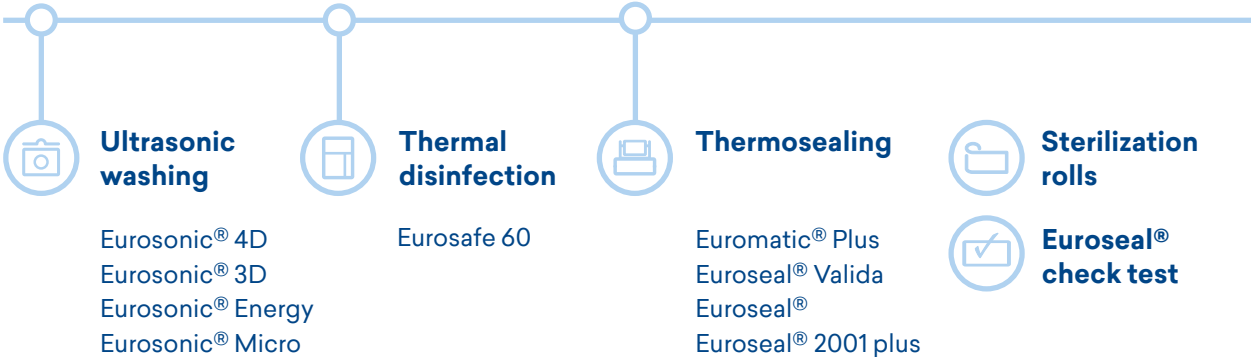

Euronda Pro System is a total protection system for practices that has been developed to ensure the safety of staff, patients, instruments and working environments. There are a number of steps in the sterilization process and it will only be successful if each one - from collection to storage - is carried out properly. Thanks to the Pro System line, it is possible to implement a cutting-edge, effective, efficient protocol that can be followed on a regular basis and increase the safety of a practice while optimizing its resources.



Sterilization



Autoclave

E10
E9 Next
E8



Tests



Traceability / Retrieving



Water treatment

Aquasmo
Aquabox
Aquafilter1 to 1
Aquadist

E8

Smart sterilisation is a question of balance.



Reliability

Control systems and vanguard functions make sure that processes and results are consistent over time a Euronda Pro-System hallmark.



Performance

Powerful, fast and smart: it keeps consumption down and adapts cycle length to load.



Design

Elegant, compact and modern: E8 an harmonious combination of fine aesthetics and total functionality.



Ergonomics

Easy to install and even easier to use. E8 has been designed to save space and make healthcare professionals' lives simpler.



Innovation

All Euronda Pro-System's top technology concentrated in an autoclave that suits any practice.



Traceability

E8's expandable traceability system allows for the integration of SD Wi-Fi or two different kinds of printer, according to needs.



Straightforward, high-performing and affordable: E8 brings together all Euronda's top technology to strike a perfect balance between innovation & ergonomics, power & consumption and customisation & usability. The end result is a state-of-the-art autoclave which perfectly meets the requirements of all practices.

E8 boosts efficiency and makes your job easier, whilst delivering total reliability and longevity. E8 is the most affordable way to reap the advantages of all the Pro-system sterilisation solutions.



Reliability

Efficiency and safety that stand the test of time

Constant safety and steadfast efficiency - this is what E8 is all about. What you get is a smart sturdy autoclave of the utmost flexibility developed to adapt to the various requirements of any practice and to outperform. E8 integrates and harmonises the best solutions and functions of all Euronda Pro-System devices. The various components, control systems and software strive together actively to give you absolute reliability.

Euronda

Pro System

E8





Water quality sensor

The built-in conductivity meter monitors water quality and, if it is not satisfactory, E8 informs the operator with special messages on the display.



Dirt Control System

It is located in the hydraulic circuit and it makes the dirt easily flow in the used-water tank, so that the autoclave can work without problems.



Air-water separator

The air-water separator device, designed and built into the tank unit, is a real “life saver” for the vacuum pump. The pumps used on machines of this level are essential to achieve proper sterilisation, but are very delicate as they are in constant contact with flows containing high temperature steam, air, dirt and chemical waste from lubricating oils found on instruments being sterilised (wands, turbines,..). These streams are channelled into the separator device which separates the air from the other components before they enter the vacuum pump. This phase allows the pump to operate in ideal working conditions, preserving the efficiency of the device.



Support software

Euronda has developed a number of software applications to support technicians during the installation, diagnosis and maintenance processes. This helps to guarantee peak performance from E8 at all times while cutting assistance times and costs.



The instant steam generator and enhanced drying cycle ensure a rapid and superlative sterilisation process which keeps down water (300 ml of water per cycle) and energy (power usage of 2300 W at 10 A) consumption by adapting to the load.



Performance

The ideal balance between power and consumption



Efficient

The steam generator instantly produces the steam for the sterilization chamber, optimizing the water consumption in accordance with the load, making further cuts to the sterilization time and actually improving the quality of the steam generated.



Customization

First and foremost, E8 can run 5 different type B cycles (121°C, 134°C, 134°C Prion, 134°C Rapid and 134°C Rapid Prion) in full compliance with the UNI EN 13060 standard, as well as 3 test cycles (Vacuum, Helix, and Bowie and Dick). In addition, thanks to the password-activated Personal functions, it is also possible to run Light cycles (type N cycles - N134 and N121) and Light & Stock cycles (type S cycles - S134 and S121).



Eco-Friendly

Fast and efficient at the same time. The Euronda Pro System technology assesses the actual size of each load and adapts the sterilization settings to guarantee savings in terms of water, energy and time.

Design

A perfect blend of aesthetics and functionality

With its elegant contemporary look, E8 underpins and reinforces the new style launched by Euronda autoclaves. The soft-touch colour display is protected by a polycarbonate screen and enhanced with a distinctive front panel in light grey.

Euronda
Pro System

E8





Elegant

Clean modern lines for a practical reliable autoclave endowed with all the signature details of Euronda quality.



Functional

The exclusive soft-touch display comes with a protective polycarbonate screen designed for easy cleaning.



Compact

Its linear design, compact size and adjustable supports mean it easily fits into small spaces or on the work top.



20/10/2017

12:50



Operators

Load Validation

Drying Time

E-Timer

Standby



Innovation

Top technology at your fingertips

E8 encapsulates the best of Euronda's Pro System cutting-edge technology and brings it within everyone's reach. Programming and customisation functions, an extremely user-friendly interface and incredibly innovative systems to keep the autoclave's performance standards consistent over time are all technological features which in E8 are synonymous with simplicity.



The smart autoclave

Readily understandable and easy to use, E8 is a prime example of how simple and intuitive technology can be.



Soft-touch display

The soft-touch colour display and brand-new clear fuss-free icons enable healthcare professionals to work intuitively and fast. The user interface has been specially designed to speed up and optimise routine work in the practice.



E-Timer

Make the most of your time! Thanks to the innovative E-Timer, you can set tests and sterilization cycles to start at whatever time you like, allowing you to save time and start the working day at full speed.

Ergonomics

E8 makes
everything easier





Devised to fit into your spaces

Endowed with a new rear ventilation system, it fits snugly on the shelves of the sterilisation room.



Energy efficiency at your service

The choice of containing the power used within 2300 W allows the installation on a 10 A line.



Inspection[®] System

The tank compartment access system is extremely quick and simple. The upper cover is made of an innovative engineering plastic. It is held in place by a magnetic system which makes it easy to open at any time and enables even less proficient people to clean it easily and frequently. This guarantees safe sterilization that remains consistently effective in the long term.



Modular structure

The side panels are made of cutting-edge materials and they are extremely easy to remove. In addition, the components inside the machine are easily accessible and positioned in a logical manner. This helps to make maintenance easier, faster and more effective.



Tank compartment access system

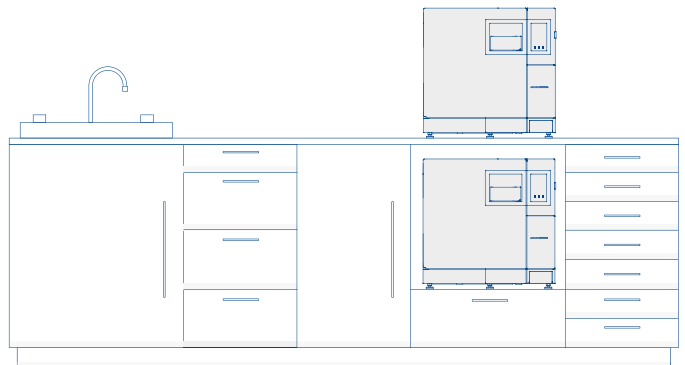

Perfectly flush mounted in sterilization room units

Traceability

Keep the sterilisation process constantly under control

Traceability is a hallmark of all Euronda Pro-System autoclaves, the first to have an expandable traceability system. E8 is no exception to the rule. All sterilisation cycles are saved to an SD card for transferral onto a computer also via an optional Wi-Fi connection. With E8, two different kinds of printers can be added according to your requirements, so you can save time without compromising safety standards.



Print Set 1
Built-in thermal
paper printer



Print Set 2
Built-in adhesive
label printer

Euronda
Pro System

E8



Expandable connectivity

A storage system on a standard integrated SD card and optional Wi-Fi connectivity so that all data can be easily transferred from the autoclave to the computer or any other device, in compliance with EN13060 standards.



Validation and load release

This function allows users to keep a digital record of the compliance of the sterilization process in both the loading phase and the unloading phase. The operator ensures that the pouches are dry and checks their integrity and the state of the instruments, while also making sure that the sterilization parameters are satisfactory.



Optional printers

E8's expandable traceability system caters to a range of needs, with a selection of 2 different optional printers. E8 can satisfy the traceability requirements of any practice and guarantee compliance with the legally established safety standards.



Starter kit

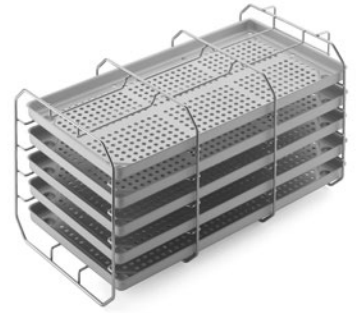

Standard tray holder

Square profile steel tray holder with a capacity of 5 standard aluminium trays. If rotated by 90°, it can hold 3 sterilization cassettes. 5 trays included.



Accessoires

- Drainage pipes
- Sponge
- Tray removal handle
- Door adjustment handle
- Funnel

Optional Print sets



Print Set 1

Built-in thermal paper printer for those who wish to print and store the results of the sterilisation cycle on a paper copy. It can be installed onboard in a few simple steps on the front of the machine.



Print Set 2

Built-in adhesive labels printer: safely tag your load. Install this simple printer device on board in a few easy steps. Save space and conveniently print your labels and bar codes.

Sterilization tests



Tips

To guarantee that the sterilisation cycle has been correctly carried out, Euronda recommends you run the check test to verify:

- maintaining of pressure vessel and hydraulic circuit pressure (Vacuum test, daily).
- the steam penetration capacity for hollow loads (Helix test, daily);
- steam penetration capacity for porous loads (Bowie & Dick test, daily);

Optional tray holders

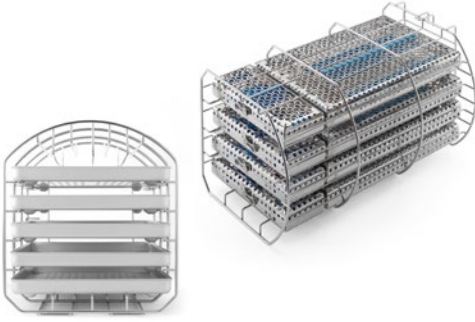

Tray holder for sterilization cassettes

Rounded steel tray holder designed to hold 5 standard aluminium trays*. If rotated by 90°, it can hold 4 sterilization cassettes. Available for 24-litre version (capacity: four 1 DIN cassettes + four 1/4 DIN cassettes).

***Trays not included**

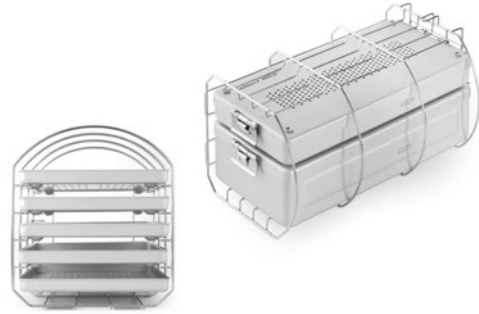

Tray holder for sterilization container

Rounded steel tray holder designed to hold 5 standard aluminium trays*. If rotated by 90°, it can hold one or more sterilization containers (max. capacity: 380 x 190 x 152 mm)

*** Only available for the 24-litre version**

*** Trays not included**

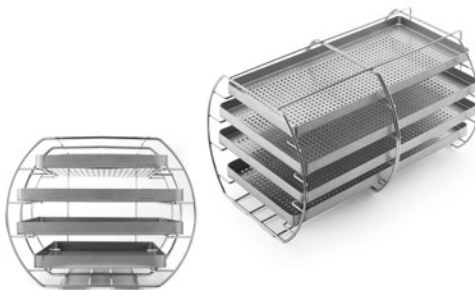

XL tray holder kit

XL rounded steel tray holder, with a capacity of 4 special aluminium trays*.

*** Only available for the 24-litre version**

*** Trays included in the kit**

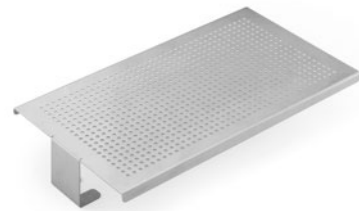

Universal support surface

A steel support surface that is suitable for loads with greater dimensions. It can be installed directly in the boiler, after removing the tray holder provided.

***Only available for the 24-litre version.**

Water treatment systems



Aquaosmo

Aquaosmo is a system that uses reverse osmosis to produce deionized water. A complex filtering system, containing no fewer than 4 filters and 1 membrane, produces a large amount of water that is suitable for supplying autoclaves and all of the equipment in dental practices, in accordance with the EN 13060 standard (<15 $\mu\text{S}/\text{cm}$). A gun for spraying water manually can be also connected. Aquaosmo is designed to be installed together with an Aquabox and connected directly to an autoclave. It can supply between 2 and 4 autoclaves at the same time if it is fitted with the special external accumulator tank kit, which has a capacity of 12 litres. Aquaosmo does not need to be connected to an electrical power supply and it can be installed directly on a work surface or inside a unit.

It can supply:

4 autoclaves

Water production:

1 litre of water every 20 min.

Min./max. supply pressure:

2 / 3 bars

Conductivity of incoming water:

Max. 650 μS

Dimensions (wxhxd):

360 x 280 x 180 mm

Weight (empty):

5.3 kg



External accumulation tank
Included in the kit



Aquabox
Included in the kit



Nozzle
Not included in the kit



Aquafilter 1 to 1

Device that produces deionised water for the autoclave, in compliance with the EN13060 standard (<15 $\mu\text{s}/\text{cm}$). It can be connected to one autoclave and deionises an average of 1 litre of water per minute. An indicator light shows the water conductivity level, allowing you to see at a glance when it's time to replace the resins. It can be equipped with an automatic shut-off device. It can be positioned on the worktop, inside a cabinet or it can be wall-mounted. The pack contains: two ion-exchange resin cartridges, a resin fixing tool, a water mains connection pipe, and a pipe and cable for connection to an autoclave.

It can supply:

1 autoclave

Water production:

1 litre of water per min.

Overall dimensions (wxhxd):

390 x 455 x 145 mm

Weight:

8.4 kg (when empty)



Aquabox

Aquabox is a device that allows Euronda autoclaves to be connected to an external supply of water that has already been treated. It is ideal for clinics that already have water treatment systems based on osmosis or other methods. It can be installed easily on all Euronda Class B autoclave models. Quality controls on incoming water are guaranteed for devices with water quality sensors.

Overall dimensions (wxhxd):

100 x 100 x 50 mm

Weight:

0.5 kg



Aquadist

Water distiller that boils water and condenses the steam to obtain distilled water. It distils 0.7 litres of water per hour. 4 litres capacity. It passes all safety tests, complying with all electromagnetic compatibility standard (2014/30/EU) and low voltage standard (2014/35/EU) requirements.

Water production:

0,7 litre of water per hour

Overall dimensions (Øxh):

230 x 360 mm

Weight:

3.5 Kg

Sterilisation cycles

	B 134	B 121	
	Solid, porous and hollow, wrapped and unwrapped	Solid, porous and hollow, wrapped and unwrapped. Particularly indicated for plastics, turbines and handpieces	
Temperature	135.5° c	122.5° c	
Pressure	2.16 bar	1.16 bar	
Sterilization time	4'	20'	
Drying time	15'	15'	
Total time with standard loads *	29'	44'	
Maximum load solid/porous	6 kg / 2 kg	6 kg / 2 kg	

Personal functions

(activation on demand with a password)

	Light & stock cycles**		
	S 134	S 121	
	Sterilization of non-bagged or bagged solid products	Sterilization of non-bagged and plastic or bagged solid products	
Temperature	135.5° c	122.5° c	
Pressure	2.16 bar	1.16 bar	
Sterilization time	4'	20'	
Drying time	15'	15'	
Total time with standard loads *	18'	31'	
Maximum load solid/porous	4.5 kg / 1.5 kg	4.5 kg / 1.5 kg	

* Times are intended without drying. The times have a tolerance of +-5%.

** All of the cycles are available unless it is not possible due to specific national legislation.

	B 134 prion	B 134 - rapid	B 134 prion - rapid
	Prion cycle for wrapped and unwrapped solid, porous and hollow	Rapid cycle for wrapped and unwrapped solid, porous and hollow For 1 tray instruments	Rapid prion cycle for wrapped and unwrapped solid, porous and hollow For 1 tray instruments
	135.5° c	135.5° c	135.5° c
	2.16 bar	2.16 bar	2.16 bar
	18'	3'5"	18'
	15'	4'	4'
	43'	27'	42'
	6 kg / 2 kg	6 kg / 2 kg	6 kg / 2 kg

Light cycles**	
N 134	N 121
Unwrapped solid instruments	Sterilization of non-bagged and plastic solid products
135.5° c	122.5° C
2.16 bar	1.16 bar
4'	20'
4'	4'
22'	36'
4.5 kg	4.5 kg

Technical data

	E8 - 24L
Overall dimensions	460 x 455 x 610 mm (w x h x d)
Weight (machine empty with basket)	48 Kg
Power supply	230 V 50/60 Hz
Absorbed current (output)	2300 W 10 A
Operating temperature	+5 - +40°C
Operating altitude (leaving the loading cap free)	≤ 2000 m a.m.s.l.*
Minimum depth of the support surface	500 mm
Minimum width of the support surface	460 mm
Minimum space above the tank	0 mm leaving the loading cap free
Noise level	50 dB
Weight per support area (tank full and chamber with max. load)	48 + 9 = 57 kg Load on each foot: 14,3 kg
Operating range	Indoor use, maximum relative humidity 85% Maximum line-voltage deviation ±10% Installation category II, Pollution level 2
Dimension and volume	250 x 440 mm (Øxd)
Sterilization chamber sizes	180 x 160 x 380 mm (wxhxd)
Average water consumption per cycle	300 ml
Tank capacity (clean water / used water)	5 / 3.5 litres

* For altitudes higher than 2000m, please contact Euronda SPA

Safety Device

- Overpressure protection
- Accidental door opening protections
- Process appraisal system
- Real-time self diagnostic system

Compliance with harmonised standards

EN 13060
EN ISO 14971
EN 61010-1
EN 61010-2-040
EN 61326
EN 13445

Documentation

- User Manual
- Declaration of conformity chamber
- Declaration of conformity autoclave
- Warranty Certificate
- Installation chart
- Servicing handbook

Certification information

- E8 Autoclave compliant with Directive 93/42/EC and addenda.
- Class IIb device
- Chamber compliant with PED Directive 97/23/EC
- Company certification: ISO 9001, ISO 13485

Technical Specifications

Overall required space (mm)

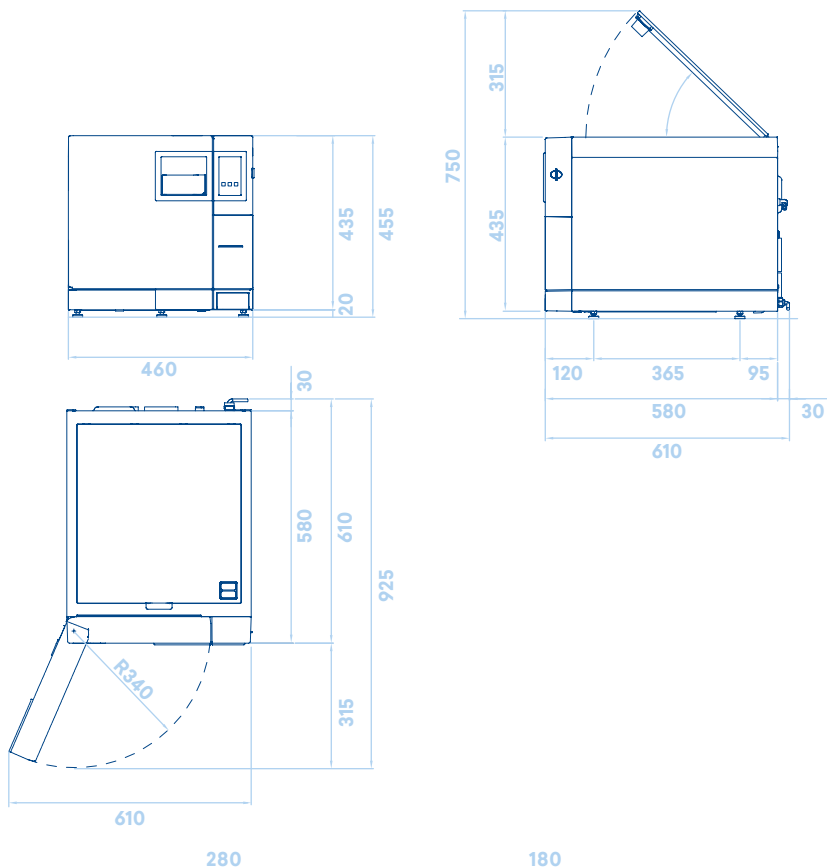

Sterilization chamber sizes (mm)

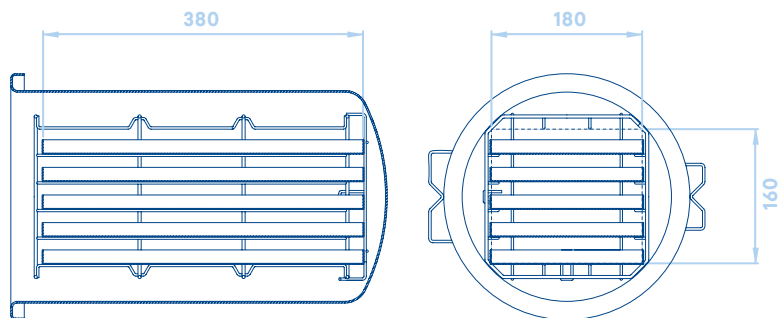

Euronda Spa © 2017

This catalogue
cannot be copied,
scanned or reproduced
by any means.
All rights reserved.

Picture, description,
quoting, dimension
and technical data
have to be considered
as purely indicative.

While maintaining the
basic characteristics
of the product, the
manufacturer reserves
the right to make
modifications at
any time with the sole
aim of improvement.

Euronda Spa

Via dell'Artigianato 7
36030 Montecchio Precalcino,
Vicenza, Italy

t (+39) 0445 329811
f (+39) 0445 865246
m info@euronda.com
www.euronda.com

Deutschland

Euronda Deutschland GmbH
Am Landwehrbach 5
48341 Altenberge, Deutschland

t (+49) 2505/9389-0
f (+49) 2505/9389-29
m info@euronda.de
www.euronda.de

France

Euronda France
Zac Les Vallées, Avenue de Bruxelles
60110 Amblainville, France

t +33 (0) 3 44 06 69 70
f +33 (0) 3 44 02 03 89
m info@euronda.fr
www.euronda.fr

España

Euronda Spa
Identyd, Av. Cabezo de Torres 4
30007 Murcia, España
Atención al cliente: 900102034

t (+34) 868187961
m info@euronda.es
www.euronda.es

Russian Federation

OOO Finstar
5/2a Varshavskaya str.
196128, St. Petersburg, Russia

t +7 (812) 635 88 94
m info@finstartech.ru
www.euronda.com

Euronda[®]